

CE



User's Guide



TM

Shown with
Built-in Distance
Measuring Option
and Digital Video
Camera Attachment

Shop online at

omega.com[®]

Ω OMEGA[®]

omega.com

e-mail: info@omega.com

For latest product manuals:

omegamannual.info

ISO 9001
CERTIFIED
CORPORATE QUALITY
STAMFORD, CT

ISO 9002
CERTIFIED
CORPORATE QUALITY
MANCHESTER, UK

**OS530LE, OS532E, OS53xE-CF,
OS533E, OS534E, OS530HRE,
OS523E, OS524E OMEGASCOPE[®]
Handheld Infrared Thermometer**



OMEGAnet® Online Service omega.com	Internet e-mail info@omega.com
---	---

Servicing North America:

U.S.A.:
ISO 9001 Certified
One Omega Drive, Box 4047
Stamford, CT 06907-0047
Tel: (203) 359-1660
FAX: (203) 359-7700
e-mail: info@omega.com

Canada:
976 Bergar
Laval (Quebec) H7L 5A1, Canada
Tel: (514) 856-6928
FAX: (514) 856-6886
e-mail: info@omega.ca

For immediate technical or application assistance:

U.S.A. and Canada: Sales Service: 1-800-826-6342/1-800-TC-OMEGA®
Customer Service: 1-800-622-2378/1-800-622-BEST®
Engineering Service: 1-800-872-9436/1-800-USA-WHEN®

Mexico:
En Español: (001) 203-359-7803
e-mail: espanol@omega.com
FAX: (001) 203-359-7807
info@omega.com.mx

Servicing Europe:

Czech Republic: Frystatska 184, 733 01 Karviná, Czech Republic
Tel: +420 (0)59 6311899
FAX: +420 (0)59 6311114
Toll Free: 0800-1-66342
e-mail: info@omegashop.cz

Germany/Austria: Daimlerstrasse 26, D-75392 Deckenpfronn, Germany
Tel: +49 (0)7056 9398-0
FAX: +49 (0)7056 9398-29
Toll Free in Germany: 0800 639 7678
e-mail: info@omega.de

United Kingdom: One Omega Drive, River Bend Technology Centre
ISO 9002 Certified
Northbank, Irlam, Manchester
M44 5BD United Kingdom
Tel: +44 (0)161 777 6611
FAX: +44 (0)161 777 6622
Toll Free in United Kingdom: 0800-488-488
e-mail: sales@omega.co.uk

It is the policy of OMEGA Engineering, Inc. to comply with all worldwide safety and EMC/EMI regulations that apply. OMEGA is constantly pursuing certification of its products to the European New Approach Directives. OMEGA will add the CE mark to every appropriate device upon certification.

The information contained in this document is believed to be correct, but OMEGA accepts no liability for any errors it contains, and reserves the right to alter specifications without notice.

WARNING: These products are not designed for use in, and should not be used for, human applications.



Remove the Packing List and verify that you have received all equipment, including the following (quantities in parentheses):

- OS530/OS520 Series Handheld Infrared Thermometer (1)
- AA Size Lithium Batteries (4)
- Soft Cover Carrying Case (1)
- Analog Cable (1)
- RS232 Cable (only for OS533E, OS534E, OS523E, OS524E)
- CD Software (only for OS533E, OS534E, OS523E, OS524E)
- Quick Start Manual (1)

Accessories

Model No.	Description
UNI-ADAP-9V	100-240 Vac adapter, 9 Vdc @1.7A
OS520-RCC	Hard Carrying Case, Standard
OS520-SC-RCC	Hard Carrying Case, Large
88013K	Surface Probe, K Type T/C, up to 815°C (1500°F)
88001K	Surface Probe, K Type T/C, up to 482°C (900°F)
CAL-3-IR	NIST Traceable Calibration
SC-520	Sighting Scope
HH-DM	Distance Measuring Meter
DV-CAM	Digital/Video Camera

If you have any questions about the shipment, please call Customer Service at:

1-800-622-2378 or 203-359-1660. We can also be reached on the Internet at:

omega.com

e-mail: cservice@omega.com

When you receive the shipment, inspect the container and equipment for signs of damage. Note any evidence of rough handling in transit. Immediately report any damage to the shipping agent.

NOTE

The carrier will not honor damage claims unless all shipping material is saved for inspection. After examining and removing contents, save packing material and carton in the event reshipment is necessary.



	Page
Unpacking Instructions	i
Chapter 1 General Description	1-1
1.1 Introduction	1-1
1.2 Parts of the Thermometer	1-5
1.2.1 Front of the Thermometer	1-5
1.2.2 Rear of the Thermometer	1-7
Chapter 2 Using the Handheld Infrared Thermometer	2-1
2.1 How to Power the Thermometer	2-1
2.1.1 Battery Operation	2-1
2.1.2 AC Power Operation	2-1
2.2 Operating the Thermometer	2-2
2.2.1 Measurement Techniques	2-6
2.3 Real Time Mode (Active Operation)	2-8
2.3.1 Adjusting Emissivity	2-11
2.3.2 Using the LOCK Function	2-11
2.3.3 Using the Trigger Function	2-11
2.3.4 Using the Distance Function	2-12
2.3.5 Laser Sighting Status	2-15
2.3.6 Calculating Temperature Values	2-15
2.3.7 Changing the Temperature from °F to °C (or vice versa)	2-16
2.3.8 Turning on the Display Backlighting	2-16
2.3.9 Thermocouple Input (OS532E, OS533E, OS534E)	2-16
2.3.10 Using the Alarm Functions	2-17
2.3.11 Using Ambient Target Temperature Compensation (OS533E, OS534E, OS523E, OS524E)	2-19
2.3.12 PC Interface Software (OS533E, OS534E, OS523E, OS524E)	2-20
2.3.13 PC Interface Commands	2-25
2.3.14 Storing Temperature Data on Command (OS533E, OS534E, OS523E, OS524E)	2-27
2.3.15 Logging Temperature Data in Real Time (OS533E, OS534E, OS523E, OS524E)	2-28
2.3.16 Erasing the Temperature Data from Memory	2-29
2.4 Recall Mode (Passive Operation)	2-30
2.4.1 Reviewing the Last Parameters	2-32
2.4.2 Reviewing Previously Stored Temperature Data (OS534E, OS523E, OS524E)	2-32
Chapter 3 Laser Sighting	3-1
3.1 Warnings and Cautions	3-1
3.2 Description	3-2
3.3 Operating the Laser Sighting	3-3
3.4 Laser Sighting Status	3-3
Chapter 4 Sighting Scope	4-1
4.2 Installing and Operating the Sighting Scope	4-1

Chapter 5	Digital Video Camera	5-1
5.1	Camera Parts	5-1
5.2	Battery Installation	5-1
5.3	Turning Camera ON/OFF	5-1
5.4	Menu Selection	5-1
Chapter 6	Maintenance	6-1
6.1	Replacing the Batteries	6-1
6.2	Cleaning the Lens	6-2
6.3	Calibrating the Thermometer	6-2
6.4	Servicing the Laser Sighting	6-2
Chapter 7	Troubleshooting Guide	7-1
Chapter 8	Specifications	8-1
Chapter 9	Glossary of Key Strokes	9-1
Appendix A	How Infrared Thermometry Works	A-1
Appendix B	Emissivity Values	B-1
Appendix C	Determining an Unknown Emissivity	C-1
Index		I-1

1.1 Introduction

The OS530E/OS520E series Handheld Infrared (IR) Thermometers provide non-contact temperature measurements up to 4500°F. They offer effective solutions for many non-contact temperature applications, including the following:

- Predictive Maintenance: Tracking temperature shifts which indicate pending failure in solenoid valves.
- Energy Auditing: Locating wall insulation voids to reduce building heating costs.
- Food Processing: Taking accurate temperature readings without direct contact with the food or packaging material.

The IR thermometer provides information at a glance — the custom backlit dual digital LCD displays both current and minimum, maximum, average or differential temperatures. This versatile instrument provides:

- Measurable target distances from 5 inches to approximately 100 feet
- Emissivity adjustable from 0.1 to 1.00 in 0.01 steps provides ease of use when measuring a variety of surfaces.
- Built-in Laser sighting in Circle & Dot configurations.
- Thermocouple input available.
- Distance Measurement available, either field mountable or built-in.
- Digital/Video Camera Option available
- An electronic trigger lock feature set via the keypad allows continuous temperature measurement up to 10 times per second.
- Audible and visual alarms. The high and low alarm points are set via the keypad.
- 1 mV per degree (°F or °C) analog output, which allows interfacing with data acquisition equipment (including chart recorders, dataloggers and computers). OS524E provides 0.5 mV/Deg.
- Last temperature recall (Hold).
- Backlit display useful in low ambient light conditions.
- Powers from 4 AA size batteries or an ac adapter.
- RS232 serial communication to a PC or printer. This allows downloading data for further analysis.
- Ambient target temperature compensation. This provides more accuracy for measuring low emissivity targets.
- Record up to 800 temperature data points. Review the recorded data on the thermometer LCD, as well as downloading the data to a PC.

The thermometer is easy to use:

- Units have standard “V” groove aiming sights.
- Integral tripod mount permits hands-free operation, if necessary.
- Temperature readings are switchable from °F to °C via the keypad.
- Parameters, such as target material emissivity and alarm setpoints, can be set and remain in memory until reset.

This instrument has a rugged and functional design, including:

- Sealed keypad display.
- Convenient trigger operation.
- Soft carrying case and wrist strap, for safety and ease of carrying.
- Rubber boot around the lens and the display.

Table 1-1. OS530 Series Handheld Infrared Thermometer Features

Features	OS530LE	OS532E	OS533E	OS534E
Accuracy*	±1% rdg	±1% rdg	±1% rdg	±1% rdg
Range	-10 to 1000°F -23 to 538°C	-10 to 1000°F -23 to 538°C	-10 to 1000°F -23 to 538°C	-10 to 1600°F -23 to 871°C
Emissivity	adjustable	adjustable	adjustable	adjustable
Backlit Dual Display	standard	standard	standard	standard
Distance to Spot Size Ratio	10:1	10:1	20:1	30:1
Differential Temperature	standard	standard	standard	standard
Min/Max Temperature	standard	standard	standard	standard
Average Temperature	standard	standard	standard	standard
High Alarm	standard	standard	standard	standard
Thermocouple Input	—	standard	standard	standard
Audible Alarm & Indicator	standard	standard	standard	standard
Analog Output	1 mV/deg	1 mV/deg	1 mV/deg	1 mV/deg
Built-in Laser Sighting	dot/circle	dot/circle	dot/circle	dot/circle
Trigger Lock	standard	standard	standard	standard
Last Temperature Recall	standard	standard	standard	standard
Low Alarm	—	—	standard	standard
Ambient Target Temperature Compensation	—	—	standard	standard
RS232 Interface	—	—	standard	standard
Data Storage	—	—	—	standard
Distance Measurement	Optional			
Digital Camera	Optional			

Features	OS530HRE	OS530LE-CF	OS533E-CF	OS534E-CF
Accuracy*	3°F (1.7 °C)	±1% rdg	±1% rdg	±1% rdg
Range	-22 to 250°F -30 to 121°C	-10 to 1000°F -23 to 538°C	-10 to 1000°F -23 to 538°C	-10 to 1600°F -23 to 871°C
Emissivity	Adjustable	Adjustable	Adjustable	Adjustable
Display Resolution	0.1°F/0.1°C	1°F or 1°C	1°F or 1°C	1°F or 1°C
Backlit Dual Display	std	std	std	std
Field of view	20:1	0.15"@6"	0.15"@6"	0.15"@6"
Differential Temperature	std	std	std	std
Min/Max Temperature	std	std	std	std
Average Temperature	std	std	std	std
High Alarm	std	std	std	std
Low Alarm	---	---	std	std
Audible Buzzer & Indicator	std	std	std	std
Ambient Target Temp Compensation	---	---	std	std
Analog Output	1 mV/Deg	1 mV/Deg	1 mV/Deg	1 mV/Deg
RS232 Output	---	---	std	std
Data Storage	---	---	---	std
Built-in Laser sighting	Dot/Circle	Dot	Dot	Dot
Trigger Lockstd	std	std	std	std
Last Temperature Recall	std	std	std	std
Thermocouple Input	---	---	std	std
Distance Measurement	Optional	Not Recommended		
Digital Camera	Optional			

* The temperature accuracy is 1% of Rdg or 2°C (3°F) whichever is greater.

Features	OS523E**	OS524E
Accuracy	±1% rdg	±1% rdg
Range	0 to 2500°F (-18 to 1371°C)	1000 to 4500°F (538 to 2482°C)
Emissivity	adjustable	adjustable
Backlit Dual Display	standard	standard
Distance to Spot Size Ratio	varies**	110:1
Differential Temperature	standard	standard
Min/Max Temperature	standard	standard
Average Temperature	standard	standard
High Alarm	standard	standard
Low Alarm	standard	standard
Audible Alarm & Indicator	standard	standard
Ambient Target Temperature Compensation	standard	standard
Analog Output	1 mV/deg	0.5 mV/deg
RS-232 Output	standard	standard
Thermocouple Input	—	—
Data Storage	standard	standard
Built-in Laser Sighting	dot/circle	dot/circle
Trigger Lock	standard	standard
Last Temperature Recall	standard	standard
Distance Measurement		Optional
Digital Camera		Optional

** OS523E provides three field of views:

	Distance to Spot Size Ratio
OS523E-1	30:1
OS523E-2	60:1
OS523E-3	68:1

1.2 Parts of the Thermometer

1.2.1 Front of the Thermometer

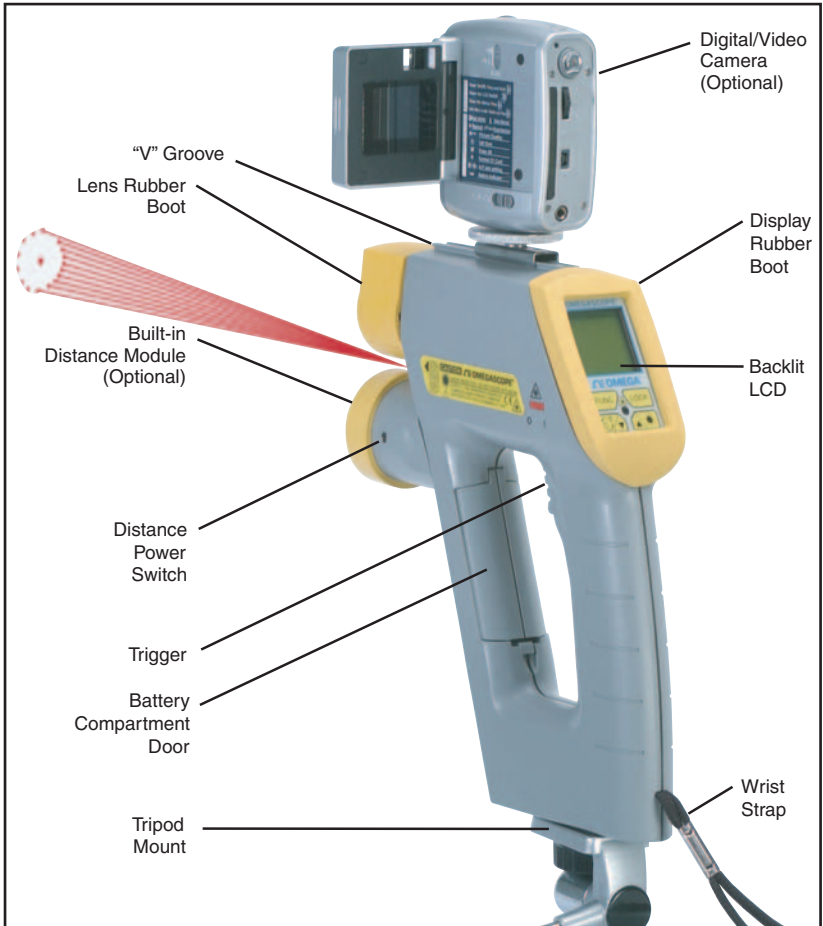

Figure 1-1. OS530E/OS520E Series Handheld Infrared Thermometer Front View

The display is shown in more detail in Figure 1-2 and described in Table 1-2. There are no user-serviceable parts in the thermometer.

Refer to Chapter 3 for Laser Sight information.

Figure 1-3 shows the various jacks for analog output, thermocouple input and the ac adapter to the thermometer. The figures also show the location of the Laser Power Switch, Dot-Circle Switch, and Laser Beam Aperture. More details are provided in Section 2.2.1.

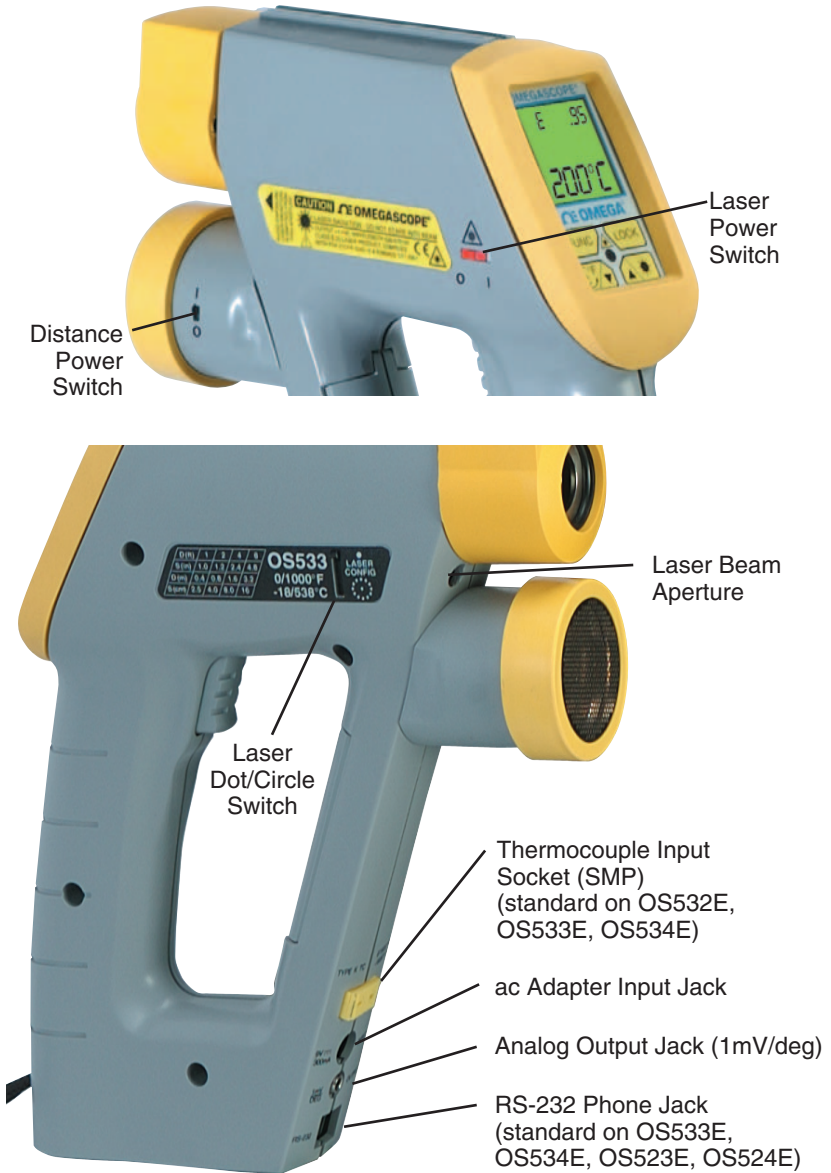

Figure 1-3. OS530E/OS520E Series Handheld Infrared Thermometer Various Views

2.1 How to Power the Thermometer

2.1.1 Battery Operation

Invert the thermometer and install 4 fresh AA size batteries as shown in Figure 2-1. Make sure the batteries' polarities are correct, the batteries are not put in backwards, and are of the same type.

NOTE

If the **LOWBAT** icon flashes, the batteries must be replaced with fresh batteries immediately.

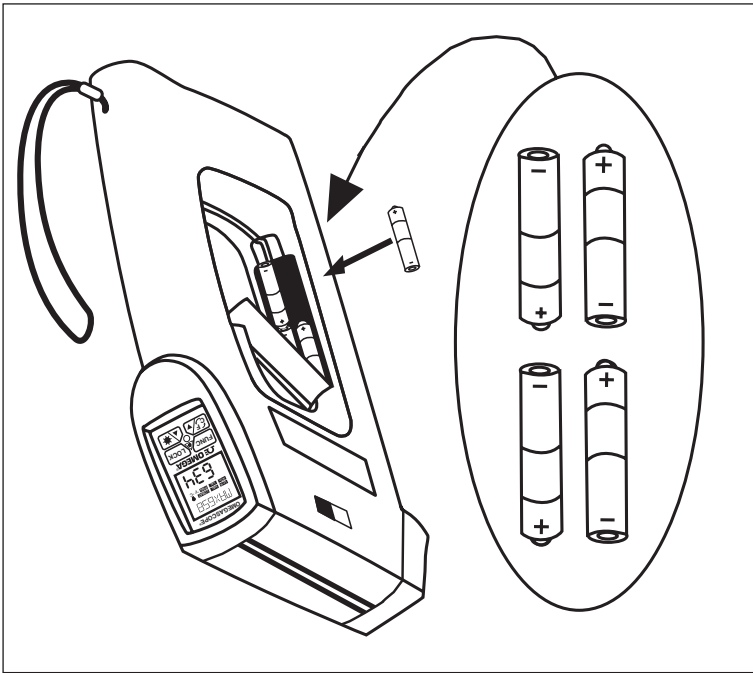

Figure 2-1. Installing the Batteries

2.1.2 ac Power Operation

The thermometer may be operated on ac power using the optional universal 100/240 Vac adapter. When operating on ac power the batteries supply backup power in case of ac power failure. The ac adapter input jack is shown in Figure 1-3.

2.2 Operating the Thermometer

- 1a. (Without the Laser Sighting) - Aim the thermometer at the target to be measured. Use the "V" groove (shown in Figure 1-1) on top of the thermometer to align the target to the thermometer's field of view. Look down the "V" groove with one eye only, in order to guarantee proper sighting. Pull and hold the trigger.
- 1b. (With the Laser Sighting) - Set the laser power switch to the ON position. Aim at the target and pull the trigger. The laser beam and the red power indicator LED will turn on while the trigger is pulled. Refer to Chapter 3 for more details on the Laser Sighting.
2. The field of view of the thermometer should fall within the area of the target being measured as shown in Figure 2-2. Figures 2-3 through 2-9 show the field of view vs distance for the various thermometers.

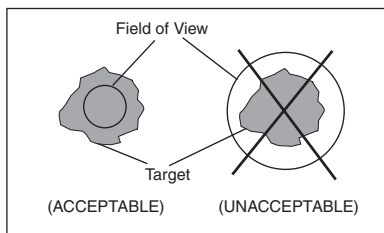

Figure 2-2. Field of View Positions

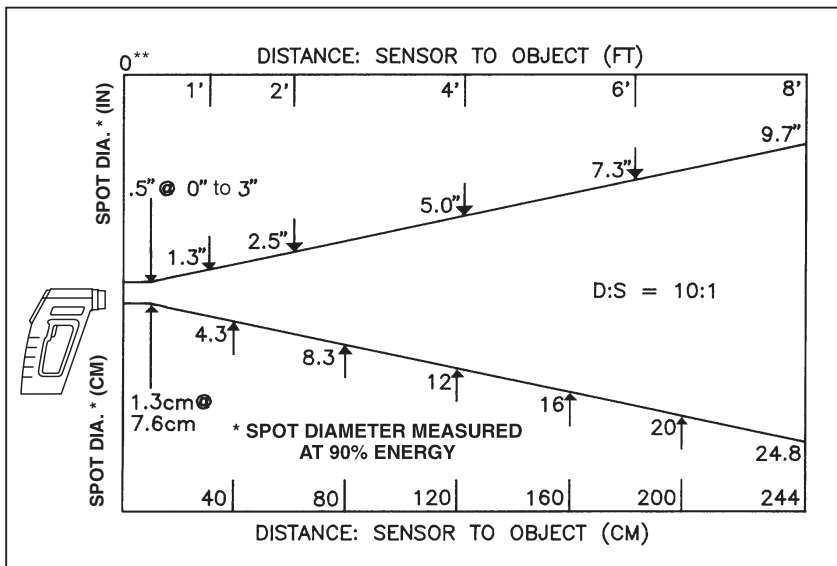

Figure 2-3. Field of View OS532E, OS530LE

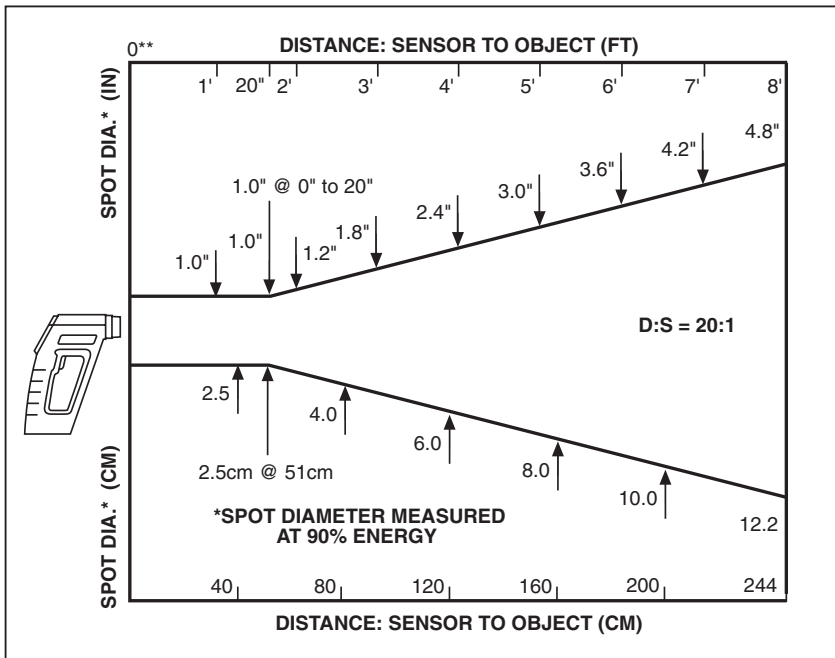

Figure 2-4 Field of View OS533E, OS530HRE

** Measurement distance is from the outside surface of the rubber boot.

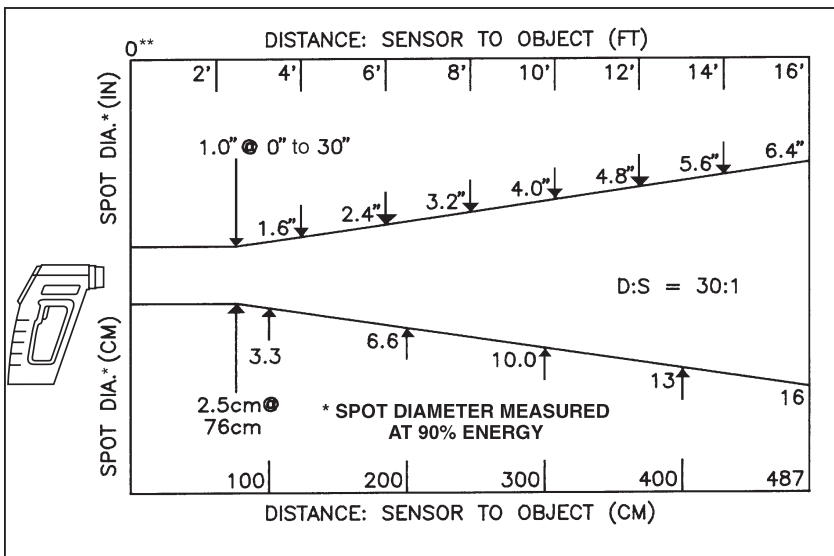

Figure 2-5 Field of View OS534E, OS523E-1

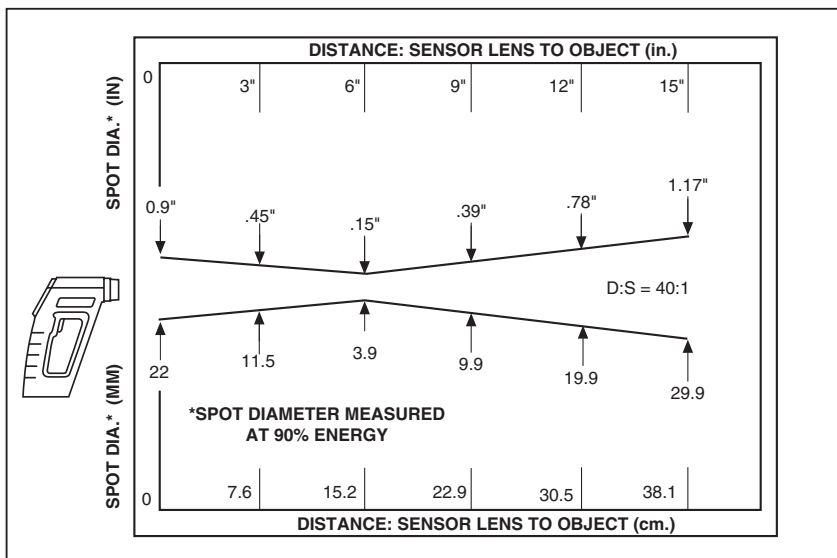

Figure 2-6 Field of View OS53xE-CF

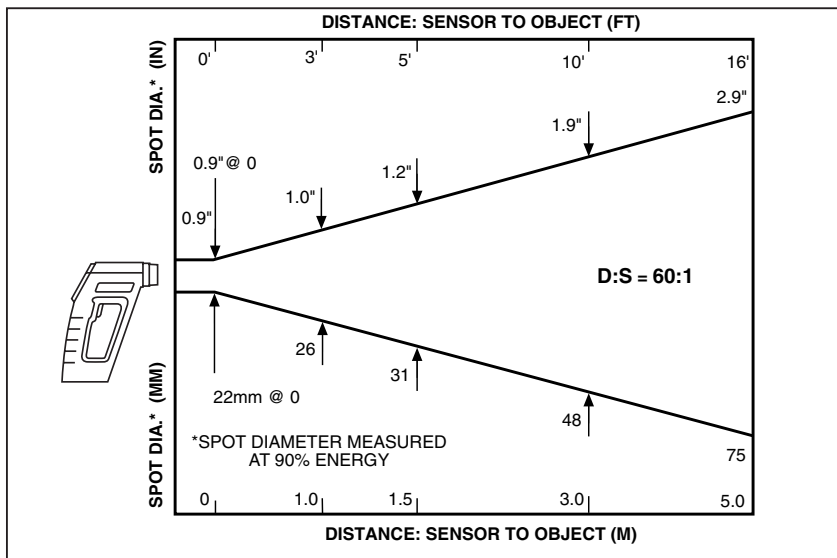

Figure 2-7 Field of View OS523E-2

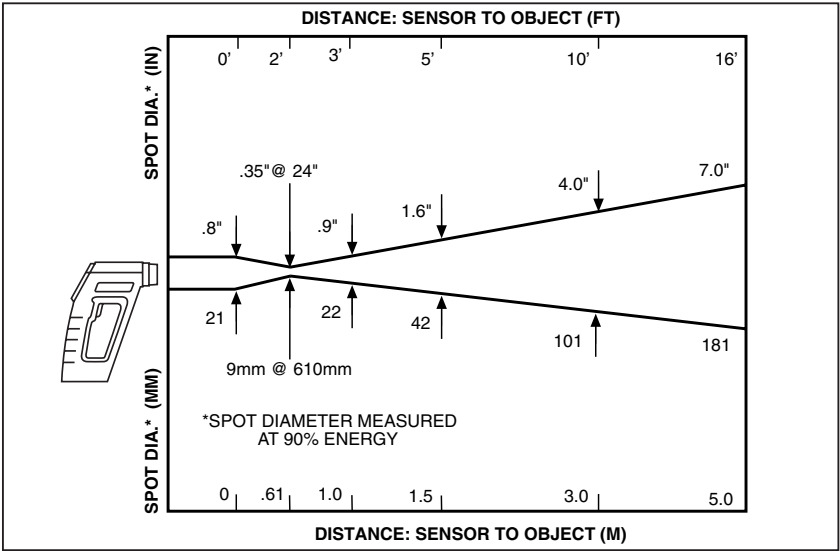

Figure 2-8 Field of View OS523E-3

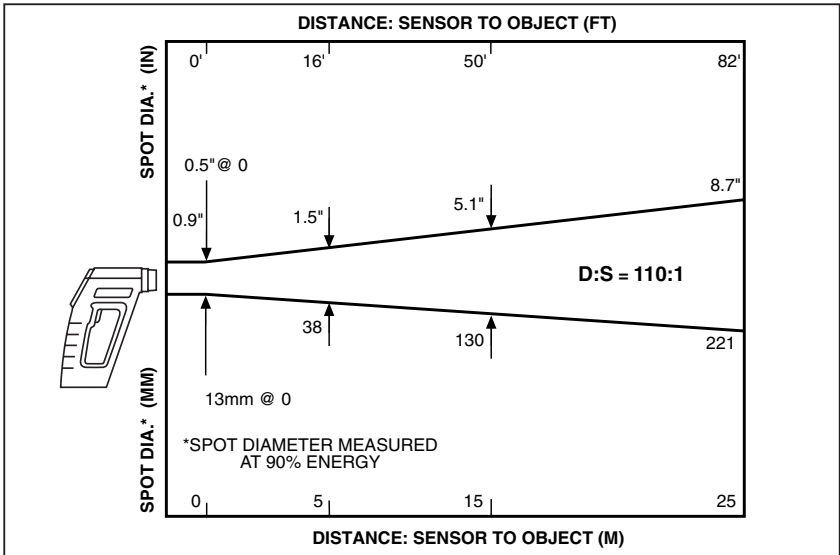













Figure 2-9 Field of View OS524E

3. The target temperature and emissivity are displayed on the LCD. Determine the emissivity of the target (refer to Appendix B). Press the  key to increment the target emissivity. Press the  key to decrement the target emissivity.
4. Press the  key to lock the trigger. The  icon will appear on the display. This allows the thermometer to operate continuously whether or not the trigger is pulled. To unlock the trigger, press the  key again or pull the trigger twice. The  icon is no longer displayed. When the trigger is pulled, the Laser Sighting as well as the display backlight will stay on .
5. After completing a temperature measurement, release the trigger. In order to conserve battery life, the thermometer goes into sleep mode and the Laser Sighting turns off.

2.2.1 Measurement Techniques

You can use the IR Thermometer to collect temperature data in any one of five different ways:

- **Spot Measurement** — Measures the temperature of discrete objects such as motor bearings, engine exhaust manifolds, etc.:
 1. Aim at the desired target and pull the trigger.
 2. If necessary, adjust the emissivity using the  and  keys.
 3. Read the temperature.
- **Differential Measurement** — Measures the temperature differential between two spots (the maximum and minimum temperatures viewed)
 1. Aim the thermometer at the first spot and pull the trigger. Press the  key to lock the trigger.
 2. If necessary, adjust the emissivity.
 3. Aim at the second spot.
 4. Adjust the emissivity of the second spot if required.
 5. To display the differential temperature, press the  key until "dIF" appears on the display.
 6. Read the differential temperature from the upper display.
 7. Press the  key to unlock the trigger.

- **Static Surface Scan** – Measures the temperature across a static surface:
 1. Aim the thermometer at a starting point and pull the trigger. Press the **LOCK** key to lock the trigger.
 2. If necessary, adjust the emissivity.
 3. Slowly move the thermometer so that the line of sight sweeps across the surface. The thermometer measures the temperature at each point on the surface.
 4. To record the temperature profile across the surface, connect the IR thermometer to a strip chart recorder. Refer to Figure 2-11 for details. The IR thermometer provides an analog output of 1 mV/degree. (0.5 mV/Deg on OS524E)
 5. After all the data has been taken, press the **LOCK** key to unlock the trigger.

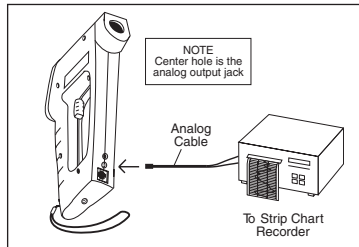

Figure 2-11 Recorder Hookup

- **Moving Surface Scan** - Measures the Temperature of Points on a Moving Surface:
 1. Mount the thermometer on a camera tripod and aim at a fixed point on the moving surface.
 2. Pull the trigger and press the **LOCK** key to lock the trigger.
 3. If necessary, adjust the emissivity. The thermometer is now set up for measuring the temperature of a moving surface.
 4. To record the temperature profile of the moving surface, connect the IR thermometer to a strip chart recorder. Refer to Figure 2-11 for details.
 5. After all data is taken, press the **LOCK** key to unlock the trigger.
- **Fixed Point Monitoring Over Time** - Monitors the temperature at a fixed point over time:

NOTE

It is recommended that you use the ac adapter for long term measurement of temperature.

1. Mount the thermometer on a camera tripod and aim at the target.
2. Connect the analog output of the thermometer to a strip chart recorder as shown in Figure 2-11.
3. Pull the trigger and press the **LOCK** key to lock the trigger.
4. If necessary, adjust the emissivity.
5. The thermometer is now set up for unattended monitoring of temperature over time. You can also download the temperature to a Serial Printer or a PC for further analysis (Models OS533E, OS534E, OS523E, OS524E).
6. After all data is taken, press the **LOCK** key to unlock the trigger.

2.3 Real Time Mode (Active Operation)

Definition: Real Time Mode is the active operational mode of the thermometer. In this mode, the thermometer constantly measures and displays temperature.

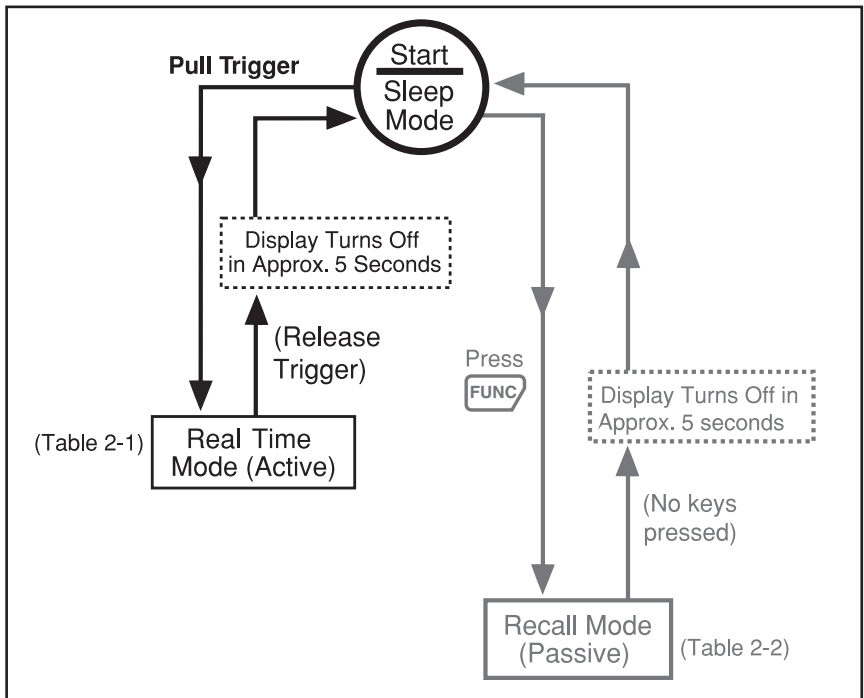

Figure 2-12. General Operational Block Diagram

Table 2-1. Functional Flow Chart when the Trigger is Pulled (Real Time Mode)

Real Time Modes				
DISPLAY MODE:	Display shows:	Press [FUNC] to...	Press [LOCK] to...	Press [C/F] or [▲/▼] to...
[E]	Emissivity Current temperature	Go to [dF/dM]	Lock or unlock Trigger [LCK]	Set Emissivity
[dF/dM]	Distance (feet or meter) Current temperature	Go to [LSR]	Set laser to Flashing or On	Press [▲/▼] to turn on/off LCD backlight
[LSR]	Laser status Current temperature	Go to [MAX]	Reset Maximum, Minimum, Diff. Average temps	Press [C/F] to change from °F to °C or feet to meter and vice versa
[MAX]	Maximum temperature Current temperature	Go to [MIN]		
[MIN]	Minimum temperature Current temperature	Go to [dIF]		
[dIF]	Differential temp Current temperature	Go to [AVG]		
[AVG]	Average temperature Current temperature	Go to [HAL]		
[HAL]	High alarm set point Current temperature	Go to [TC]	Enable/Disable [HAL]	Set High Alarm set point
[TC]	Thermocouple temp Current temperature	Go to [LAL]	—	Turn on LCD Back lite Change °F to °C
[LAL]	Low alarm set point Current temperature	Go to [AMB]	Enable/Disable [LAL]	Set Low Alarm set point
[AMB]	Ambient target temp Current temperature	Go to [PRN]	Enable/Disable [ATC]	Set Ambient Target temp
[PRN]	Data Trans. Interval Current temperature	Go to [MEM]	Enable/Disable [PRN]	Set Data Transmission Interval (Logging)
[MEM]	Memory location Current temperature	Go to [LOG]	Store temp data	—
[LOG]	Logging Current temperature	Go to [E]	Turn on/off Logging	—



NOTE: The unit of measure (°F or °C) flashes during Real Time Mode.

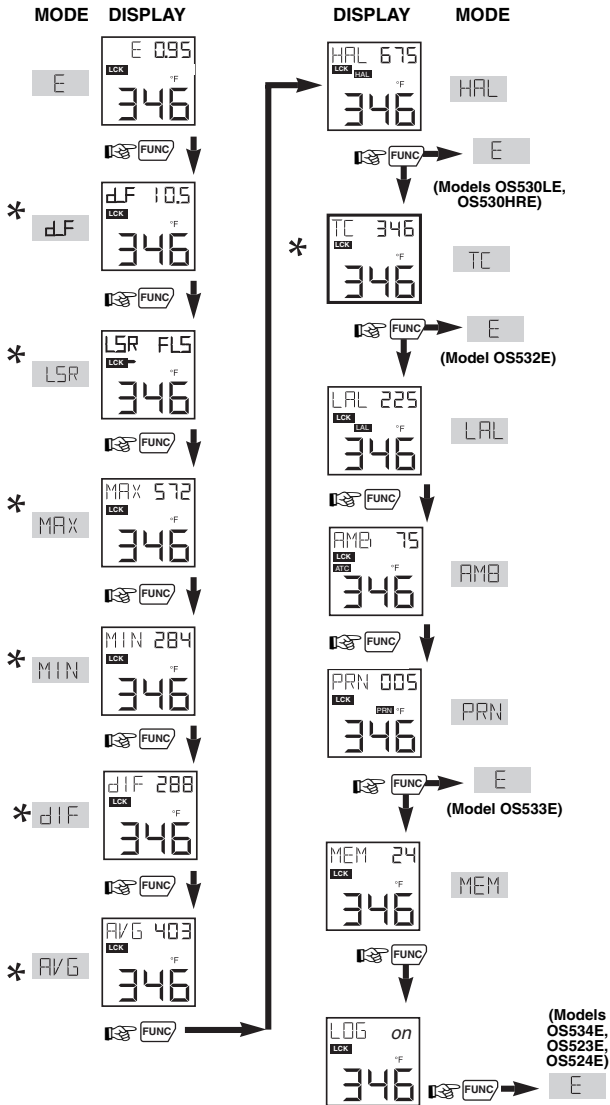



Figure 2-13. Visual Function Flow Chart

* While in these 7 modes:



Use  key to change temperature from °F to °C or vice versa.

Use  key to turn on the display backlighting.

2.3.1 Adjusting Emissivity



Refer to Appendices B and C for information on emissivity.

1. Determine the emissivity of the target.
2. Aim at the target and pull the trigger.
3. If necessary, press the  key to increment the target emissivity or press the  key to decrement the target emissivity.

NOTE



The Emissivity Display Mode (E) appears every time the trigger is pulled regardless of how the Display Mode was previously set.

NOTE



The emissivity setting does not change when the thermometer is turned off. However, when the batteries are replaced, the emissivity is reset to 0.95, the default value.

2.3.2 Using the LOCK Function

This function electronically locks the trigger mechanism:

1. Pull the trigger and press the  key to lock the trigger in the Emissivity and Distance Display Mode. The  icon will appear on the display.
2. Release the trigger. This allows the thermometer to operate continuously whether or not the trigger is pulled.

NOTE

To unlock the trigger function, while in Emissivity and Distance Display Modes press the  key again, and the  icon is no longer displayed.

The  key also enables/disables alarm functions, and resets calculated temperature values (MAX, MIN, dIF, AVG).

2.3.3 Using the Trigger Function

Besides turning on the thermometer by pulling the trigger, you can lock the trigger electronically by pressing the trigger button twice. The  icon is displayed. You can unlock the trigger by pressing the trigger button twice again.

2.3.4 Using the Distance Function

CAUTION



- There should be a clean, open line of sight from the distance device to the target, otherwise an erroneous reading will result.
- For accurate distance measurement readings, the surface must be hard, flat, and reflective to ultrasonic pulse.
- Distance measurement can not be taken through glass, or off of soft and padded surfaces, or through smoke or fog.
- The distance measurement unit must be held perpendicular to the target surface.
- The distance measurement unit is designed for indoor use only.
- Accuracy of the distance measurement unit will vary depending on environmental conditions.
- Do not aim the distance measurement unit at a person.



The thermometer provides distance measurement as an option. This function is either built-in or field mountable. The field mountable version (HH-DM) mounts on top of the thermometer and is a stand-alone device. It operates independently of the thermometer. Model HH-DM operates from a 9Vdc battery. Press the  key to measure distance. Press and hold the  key for about 2 seconds to convert distance from Feet to Meters or vice versa. Press the same  key to turn off the device or it will turn itself off in about 7 minutes.



Figure 2-14.
Model HH-DM Distance Meter



Figure 2-15. Infrared Thermometer With
Built-in Distance Measurement (-DM)



The built-in version (-DM) is an integral part of the thermometer, and distance measurement is made using the thermometer's keypad. Go to the d_F or d_M display menu. There is a slide power switch on the side of the distance module housing. Make sure the power switch is ON. Pull the trigger for about 2 seconds, and the upper display will show the distance to the target either in Feet or Meter. Releasing the trigger will turn off the distance measurement, and distance value will stay on for about 3 seconds. Pressing the  key will convert the distance value from Feet to Meters and vice versa.

NOTE

Do not operate the built-in distance module and laser sighting at the same time while operating from the batteries. It places a heavy load on the batteries.

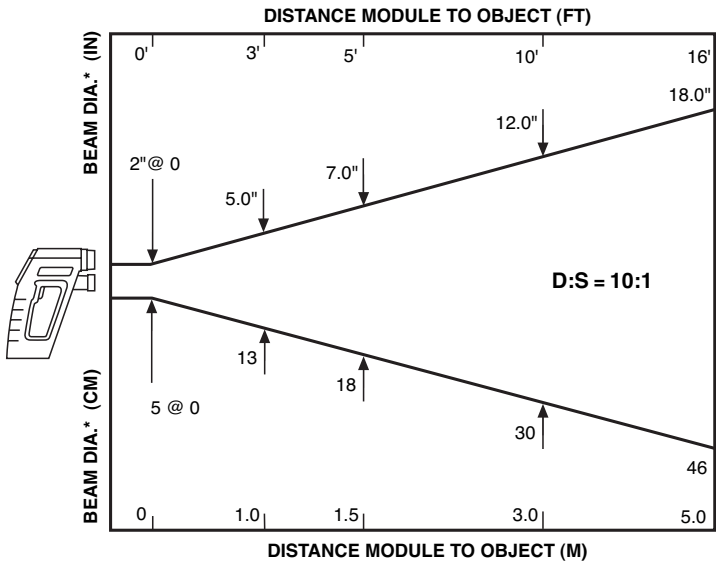

Figure 2-16. Field of View of Built-in Distance Module

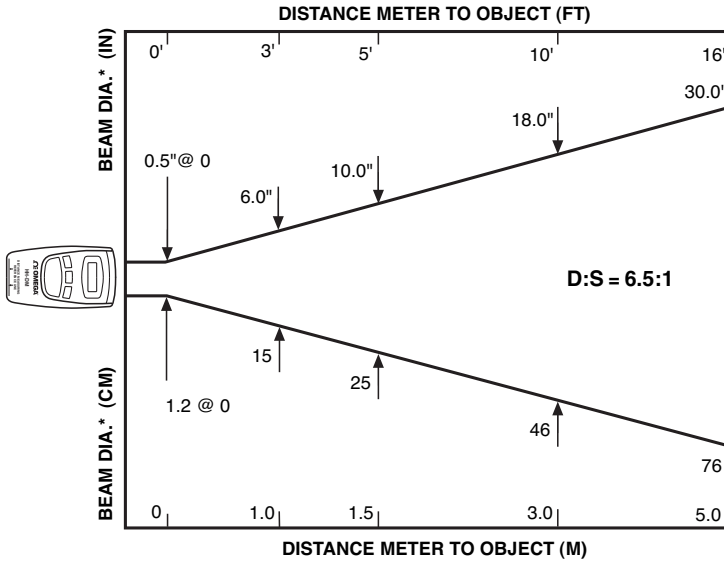

Figure 2-17. Field of View of Distance Meter HH-DM

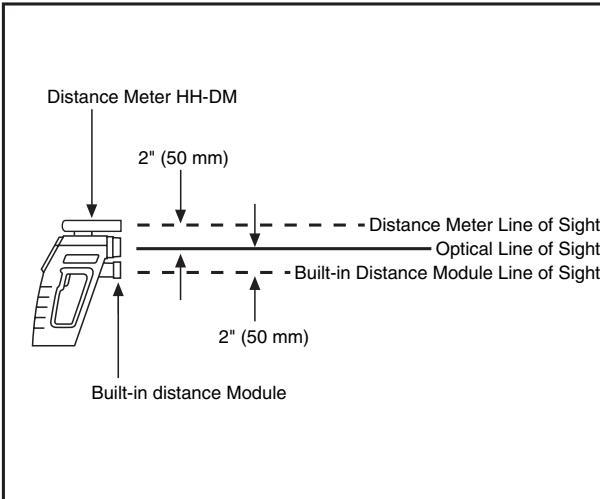

Figure 2-18. Line of Sight of the Infrared Thermometer vs. Distance Meter and Built-in Module

2.3.5 Laser Sighting Status

In the LSR display menu, the status of the laser sighting is shown either as Flashing (FLS) or continuous (on). Pressing the **LOCK** key will change the status from flashing to continuous and vice versa. There is a slide laser power switch on the left side of the thermometer's case. Set the power switch to ON position, and pull the trigger. The laser beam will turn on (either flashing or continuous depending on the status) as long as the trigger is pulled. Releasing the trigger will automatically turn off the laser beam.

2.3.6 Calculating Temperature Values

The thermometer calculates the MAX, MIN, dIF, and AVG temperatures based on the current temperature.

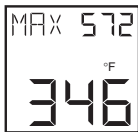

is the maximum temperature since the temperature measurement session starts (pulling the trigger).



is the minimum temperature since the temperature measurement session starts.

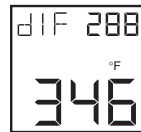

is the difference between the MAX and MIN temperatures.

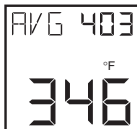

is the true average temperature since the temperature measurement session starts. The average temperature under continuous operation is accurate for a limited period of time (refer to the specifications). However, the AVG temperature function can be used indefinitely when the thermometer is operating intermittently.

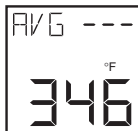

"AVG ---" is displayed when either of the following conditions occur:

1. When the average temperature measurement reaches its time period as stated in the specifications.
2. When the thermometer is trying to measure a target temperature which is outside of its measuring temperature range. At this time the corresponding MAX, MIN, dIF parameters shows ---.

To clear the "AVG ---" display, press the **LOCK** key to reset or turn off the thermometer.

NOTE

Every time the thermometer goes from the sleep mode to the Real Time mode (by pulling the trigger) or pressing the **LOCK** key (see Table 2-1) the MAX, MIN, dIF, and AVG values are reset.

2.3.7 Changing the Temperature from °F to °C (or vice versa)

During the time the thermometer displays either d_F, d_M, MAX, MIN, dIF, AVG or thermocouple temperature, press the  key to change all the temperatures from °F to °C or vice versa.



2.3.8 Turning on the Display Backlighting

During the time that the thermometer displays either d_F, d_M, LSR, MAX, MIN, dIF, AVG, or TC temperatures, press the  key to turn the display backlighting ON/OFF.

2.3.9 Thermocouple Input (OS532E, OS533E, OS534E)

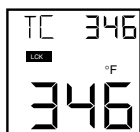
The thermometer accepts thermocouple input. It displays thermocouple temperature and the target temperature (via infrared) simultaneously. This function provides an accurate method of determining an unknown emissivity.



- To Determine an unknown target emissivity
 1. Connect a contact thermocouple probe (Type K) to the thermometer as shown in Figure 1-3.
 2. Measure the object temperature using the thermocouple probe.
 3. Aim at the object and measure the temperature via infrared.
 4. Press and hold the  key until the Emissivity Display mode (E) appears.
 5. Set the emissivity by pressing the  or  keys until the temperature reading matches the thermocouple temperature measurement.
 6. The thermometer now displays the correct object emissivity.

"TC--- is" is displayed when the thermocouple input is open or out of range (0 to 1600°F).

2.3.10 Using the Alarm Functions



The thermometer provides audible and visible alarm indications.

- To set the high alarm value:
 1. Pull the trigger. Then press and hold the **FUNC** key until the High Alarm Display Mode (HAL) appears.
 2. Press the **▲** key to increment the high alarm value. Press the **CF** key to decrement the high alarm value.
 3. Press the **LOCK** key to enable the high alarm function. The **HAL** icon appears.

If the temperature exceeds the high alarm setpoint, you will hear a beep and the **HAL** icon on the display flashes.

4. To disable the high alarm, press the **LOCK** key again, and the **HAL** icon disappears.

NOTE

If you are not in High Alarm Display Mode (HAL) when the high alarm goes off, you must press the **FUNC** key to get into the High Alarm Display Mode. Then press the **LOCK** key to disable the high alarm.

NOTE

The high alarm setpoint does not change when the thermometer is turned off. However, when the batteries are replaced, it is reset to the default value as follows:

OS530HRE:	250°F
OS530LE, OS532E, OS533E:	1000°F
OS534E:	1600°F
OS523E:	2500°F
OS524E:	4500°F



- To set the low alarm value: (OS533E, OS534E, OS523E, OS524E):

1. Pull the trigger. Then press and hold the **FUNC** key until the Low Alarm Display Mode (LAL) appears.
2. Press the **▲** key to increment the low alarm value. Press the **▼** key to decrement the low alarm value.
3. Press the **LOCK** key to enable the low alarm function. The **LAL** icon appears.

If the temperature drops below the low alarm setpoint, you will hear a beep and the **LAL** icon on the display flashes.

4. To disable the low alarm, press the **LOCK** key again, and the **LAL** icon disappears.

NOTE

If you are not in Low Alarm Display Mode (LAL) when the low alarm goes off, you must press the **FUNC** key to get into the Low Alarm Display Mode. Then press the **LOCK** key to disable the low alarm.

NOTE

The low alarm setpoint does not change when the thermometer is turned off. However, when the batteries are replaced, it is reset to the default value of -10°F (0°F for OS523E and 1000°F for OS524E).



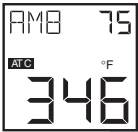



2.3.11 Using Ambient Target Temperature Compensation (OS533E, OS534E, OS523E, OS524E)





Use the Ambient Target Temperature Compensation (AMB) Display Mode when high accuracy readings under both of these conditions are required:

- The target has a low emissivity.
- The ambient temperature around the target is much higher than the ambient temperature around the infrared thermometer.

To set and activate the Ambient Target Temperature Compensation Mode:

1. Pull the trigger and press the  key to lock the trigger. Set the emissivity to 1.0 (refer to Section 2.3.1).
2. Press and hold the  key until the Average Display Mode (AVG) appears.
3. Slowly move the thermometer so that the line of sight sweeps across the area surrounding the target. The thermometer measures the temperature at each point on the surrounding area.
4. Read the average temperature value from the upper display and record it here _____.
5. Press and hold the  key until the Ambient Temperature Display Mode (AMB) appears.
6. Set the AMB temperature found in Step 4 by pressing the  key or the  key.
7. Press the  key to enable the ambient target temperature compensation. The  icon appears on the display.

NOTE

To disable this mode, press the  key again. The  icon disappears.

AMB 75
34.6

8. Press and hold the **FUNC** key until the Emissivity Display Mode (E) appears.
9. Change the emissivity to the proper value for the target being measured (refer to Section 2.3.1).
10. Aim at the target. The target temperature and emissivity are displayed on the LCD.
11. After all data is taken, press the **LOCK** key to release this mode

NOTE

To disable the Ambient Target Temperature Compensation at a later time, you must press the **FUNC** key to get into the Ambient Target Temperature Display Mode. Then press the **LOCK** key to disable it.

NOTE

The target ambient temperature does not change when the thermometer is turned off. However, when the batteries are replaced, it is reset to the default value of 75°F.

2.3.12 PC Interface Software (OS533E, OS534E, OS523E, OS524E)

Software Installation:

In order to install the PC interface software (IRTM), the PC should have the following minimum requirements:

Operating System: Windows 98SE, 2000, NT4.0, XP

32 MB RAM

Hard disk with a minimum of 20 MB free space

Place the CD into the CDROM drive. Click Start → Run... from the start menu. Click Browse to find setup program from the CD and then click OK to run setup program. The setup program will guide you through the installation process.

Sending temperature data to PC in Real Time:

1. From Windows Operation System, Go to Start → Program → Omega Infrared Temperature Measurement → IRTM then click.
2. Check the RS232 connection between the infrared thermometer and the PC. Select your serial COM Port number from the Communication Port Setting menu on the menu bar. Turn on the infrared thermometer by pulling & locking the trigger. From the program screen, click the Start button. This initiates data transmission from the thermometer to the PC.

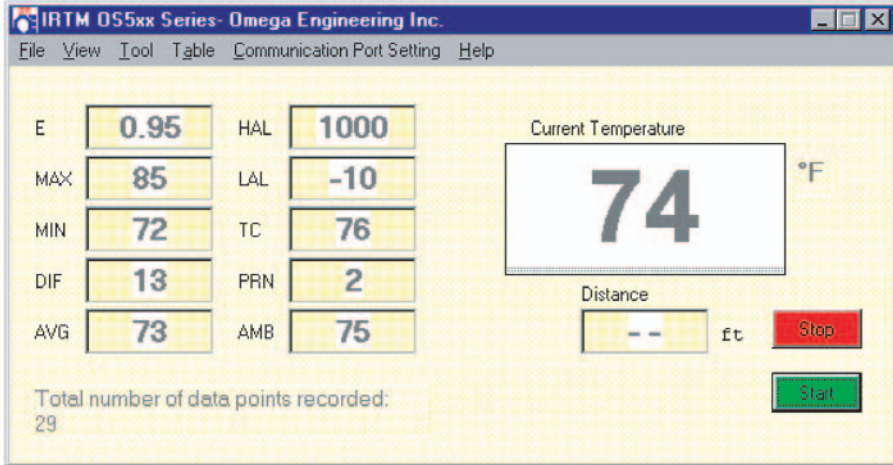

The data will fill in the screen as shown. If no data appears, you need to check the COM port number or the RS232 connection. Here is a list of data sent:

Current Temperature = 74°F

Distance=Unknown (Until distance measurement is made)

E=0.95 (Emissivity)

HAL=1000°F

(High alarm set point)

MAX = 85°F

LAL = -10°F

(Maximum Temperature)

(Low alarm set point)

MIN = 72°F

TC = 76°F

(Minimum Temperature)

(Thermocouple temperature)

DIF = 13°F

PRN = 2 second

(Differential Temperature)

(Data Transmission interval)

AVG = 73°F

AMB = 75°F

(Average Temperature)

(Target Ambient temperature)

You can also start the data transmission from the thermometer side by

going to the PRN display menu, and pressing the **LOCK** key. The **PRN**

icon will appear on the LCD and data transmission starts. You can stop the

data transmission from the PC side by clicking the Stop button. You can also

stop the data transmission from the thermometer side by pressing the **LOCK**

key again while in the PRN display menu. The **PRN** icon will disappear

from the LCD, and data transmission stops.

NOTE

The transmitted temperature data is the average temperature for the specified data transmission interval. The data transmission interval (PRN) can be set anywhere from 1 to 1999 seconds.

You can save the data into a file by going into the File menu.

Download Stored Temperature data to PC

- Run the IRTM program.
- If you are already in the IRTM program and sending temperature data from the thermometer to the PC in real time, click the Stop button to stop data transmission.
- Go to Tool menu, and click on Download stored temperature data.
- A new Download Storage Data Window will pop up, and stored data will fill in.
- When downloading data is complete, you will hear a beep.
- You can save this data into a file by going to the File menu of this window. Data can be saved as an Excel, Text or data file format.
- You can also Erase the stored data in the thermometer by going to File menu, and click on Erase stored data at thermometer.
- You can exit or close this window and go back to the previous window.

Communicating through Hyper terminal

You can get temperature data in real time or download stored data to Hyper terminal of the PC as follows:

- From Start → Programs → Accessories → Hyper terminal
- Create a name for your communication
- Set the communication settings as follows (In the Properties menu):
 - COM port (1,2,3)
 - Baud rate (9600)
 - Data Bits (8)
 - Parity (None)
 - Stop bit (1)
 - Flow control (None)

If you are sending data in real time, pull & lock the trigger on the thermometer. Press FUNC key until reaching the PRN display mode. Press the LOCK key to start data transmission to the PC. The LOCK icon will appear on the thermometer's LCD.

If you are downloading stored temperature data, press the FUNC key on the thermometer to go to the Recall mode until reaching the PRN display mode. Press the LOCK key to start the data download. When the data download is complete, you will hear a beep.

Menu Description

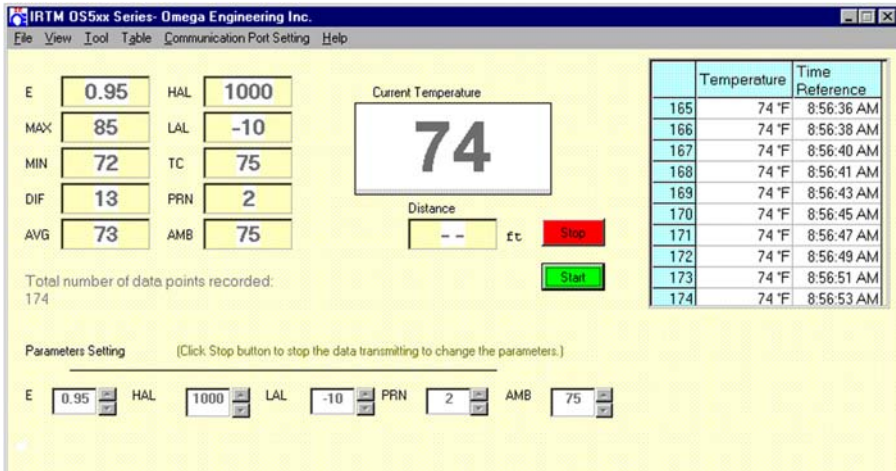
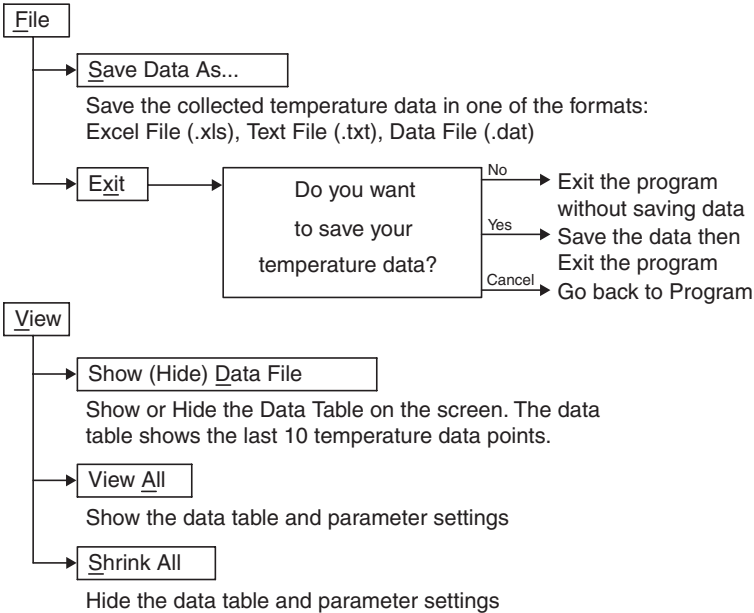

ToolStop Data Transmission to Change Parameters

Stop data transmission to be able to change parameter settings like E, HAL, LAL, etc. Any change of parameter settings will reflect on the thermometer's display. When done with parameter settings, click the Start button to restart data transmission.

Change Temperature Display between °F<-> °C

You can change the temperature display from °F to °C or vice versa. It gets reflected on the thermometer's display as well.

Reset MAX, MIN, DIF, and AVG Temperatures

Reset the MAX, MIN, DIF, AVG temperatures which will get reflected on the thermometer's display.

Download stored temperature dataFile

Save as
Erase the stored data from thermometer
Exit

TableResume Data Storage

Continue saving temperature data in the table.

Pause Data Storage

Pause saving temperature data in the table.

Clear data

Delete the saved data from the table.

Communication Port SettingCOM1COM2COM3COM4

Select an available serial port on your PC.

Help°F <-> °C Calculator

Convert temperature Engineering unit from °F to °C or vice versa.

About IRTM

Shows the software version & copyright information.

2.3.13 PC Interface Commands

You can communicate directly from the PC to the infrared thermometer. Here are the Comm port settings and communication commands from the PC:

Baud rate: 9600
 Data: 8 Bits
 One Stop Bit
 No Parity

All the PC commands to the infrared thermometer are case sensitive and terminates with a carriage return (CR). You can change parameter settings from the PC when data transmission is stopped.

Command (ASCII)	Description
IR	Get the current infrared temperature from the thermometer
T	Start sending Data stings from the thermometer to the PC
P	Stop sending data to the PC
S	Reset Min, Max, Diff, Avg temperature values on the thermometer
F1 or F0	F1 = Set Engineering unit to °F , F0 = Set Engineering unit to °C
E95	Set Emissivity to 0.95 (Thermometer sends "E:95" back as confirmation)
H500	Set High Alarm set point (HAL) to 500 (It sends "HAL:500" back as confirmation)
L20	Set Low Alarm set point (LAL) to 20 (It sends "LAL:20" back as confirmation)
A125	Set Target ambient temp (AMB) to 125(It sends "AMB:125" back as confirmation)
t	Get the data transmission interval (PRN) from thermometer
t5	Set data transmission interval (PRN) to 5 seconds. Thermometer sends back "PRN:5" as confirmation.
p	Get the data transmission flag from the thermometer. PRNF:0 means no data transmission (PRN is disabled) PRNF:1 means data transmission (PRN is enabled)
D0	Start to download stored data from IR thermometer memory
De	Erase the data from the IR thermometer memory

Here is a typical data strings from the infrared thermometer to the PC when the "T" command is activated:

OS534; E:95; MAX:78; MIN:65; DIF:13; AVG:72; DIS:1144; HAL:900; TC:74;
 TEF:0;

LAL:20; AMB:125; PRN:5; PRNF:1; IR:73; CF:0; FF:1; LF: 0;







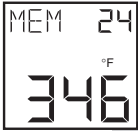

End

String	Description
E:95;	Emissivity is 0.95
MAX:78;	Maximum temperature is 78
MIN:65;	Minimum temperature is 65
DIF:13;	Differential temperature is 13
AVG:72;	Average temperature is 72
DIS:1144;	Distance is 11.44 feet (always in feet)
HAL:900;	High alarm set point (HAL) is 900
TC:74;	Thermocouple temperature is 74
TEF:0;	Thermocouple temp over-range flag (0: In range, 1: Out of range)
LAL:20;	Low alarm set point (LAL) is 20
AMB:125;	Target ambient temperature is 125
PRN:5;	Data transmission interval is every 5 seconds
PRNF:1;	PRN Flag (0: PRN disabled, No data transmission, 1: PRN enabled, Data communication active)
IR:73;	Current Infrared temperature is 73
CF:0;	Temperature engineering unit (CF:1 in Degree C, CF:0 in Degree F)
FF:1;	Temperature engineering unit (FF:1 in Degree F, FF:0 in Degree C)
LF:0	Temperature over range flag xxxx0xxx : In Range, Top xxxx1xxx : Out of Range, Top xxxxx0xx : In Range, Bottom xxxxx1xx : Out of Range, Bottom
End	End of data string

2.3.14 Storing Temperature Data on Command (OS534E, OS523E, OS524E)



The thermometer can store up to 800 temperature data points on command. This data is stored in the non-volatile memory, so removing the batteries will not affect or erase this data. To store temperature data:

1. Aim at the target and pull the trigger and press the  key to lock the trigger. The  icon will appear on the display.
2. If necessary, press the  key to increment the target emissivity or press the  key to decrement the target emissivity.
3. Press and hold the  key until the Memory Display Mode (MEM) appears.
4. Press the  key to store the target temperature at the memory location indicated. You will hear a beep to verify that the data is stored. Then the memory location is incremented by one.
5. After all data is taken, press and hold the  key until the Emissivity Display Mode (E) appears.
6. Press the  key to unlock the trigger or pull the trigger twice at any time.

2.3.15 Logging Temperature Data in Real Time (OS523E, OS524E, OS534E)

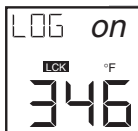





The thermometer can log temperature data in real time. The logged data is stored in the non-volatile memory, so removing the batteries will not affect or erase the data. The data is logged based on the data recording interval (PRN) which can be set anywhere from 1 to 1999 seconds. The thermometer can log up to 800 data points. Therefore, the logging period can be anywhere from 13 minutes (1 second recording interval) up to 18.5 days (1999 second recording interval). To log temperature in real time:

1. Aim at the target and pull the trigger. Press the **LOCK** key or pull the trigger twice to lock the trigger. The **LOCK** icon will appear on the display.
2. Press the **▲*** or **°F/▼** keys to adjust the Emissivity value for the target.
3. Press the **FUNC** key until the **PRN** display mode appears.
4. Set the data recording interval (seconds) by pressing the **▲*** or **°F/▼** keys.
5. Press the **FUNC** key until the LOG display mode appears.
6. Press the **LOCK** key to start logging temperature data in real time. The display will show LOG on, and the unit starts logging data based on the recording interval set in the **PRN** display menu. Press the **LOCK** key again, and the unit stops logging data. The display will show LOG off.
7. After logging data, you can turn off the thermometer by double clicking the trigger button. The **LOCK** icon will disappear and the unit turns off.

2.3.16 Erasing the Temperature Data from Memory

The user can erase all 800 temperature data points in memory at any time by using the following procedure:

1. Pull the trigger and press the  key. The  icon will appear.
2. Press the  key until reaching the MEM or LOG display mode.
3. Press the  then  keys in rapid sequence. The display shows ERASE on the top and it will beep to indicate that the stored data is erased.

NOTE

Erasing the temperature data does not erase or reset Emissivity, High and Low Alarm setpoints, printing interval and Ambient Target Temperature compensation

4. After all data is erased from memory, double click trigger to unlock the trigger.

2.4 Recall Mode (Passive Operation)

Definition: Recall Mode is the passive operational mode of the thermometer. In this mode, you may review the most recently stored temperature data and parameters.

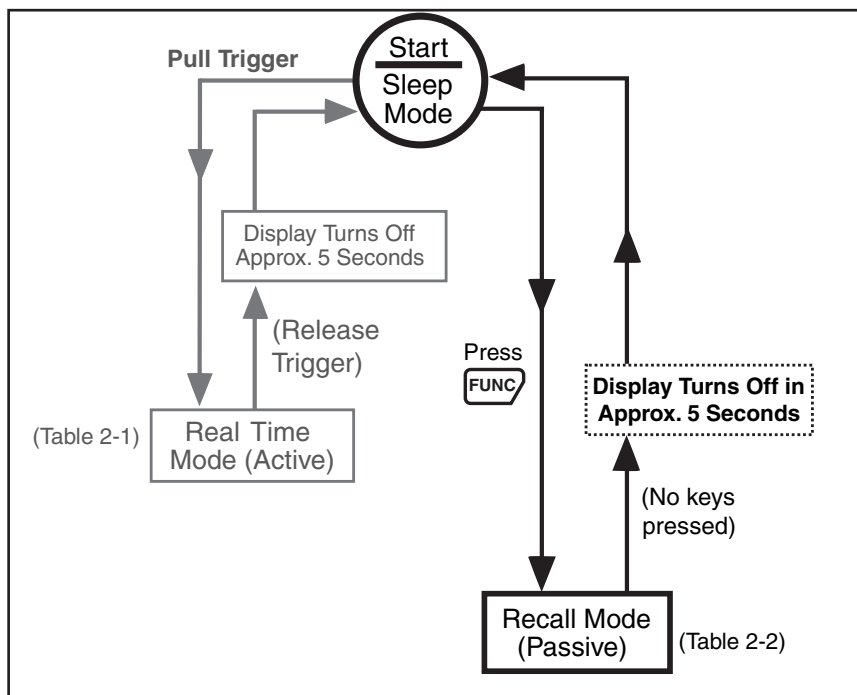

Figure 2-19. General Operational Block Diagram

NOTE

In order to get into the Recall Mode of operation, press the **FUNC** key only. Do not pull the trigger; otherwise, you will get into the Real Time (Active) Mode of operation.

Table 2-2. Functional Flow Chart (Recall Mode)

Recall Modes				
DISPLAY MODE:	Display shows:	Press FUNC to...	Press LOCK to...	Press °F/°C or ▲/▼ to...
E	Emissivity Last temperature	Go to dFdM	Disabled	Press °F/°C or ▲/▼ to... °F/°C — Disabled ▲/▼ — Changes temperature between °F and °C
dFdM	Distance (feet or meter) Last temperature	Go to LSR		
LSR	Laser status Last temperature	Go to MAX		
MAX	Maximum temperature Last temperature	Go to MIN		
MIN	Minimum temperature Last temperature	Go to dIF		
dIF	Differential temp Last temperature	Go to AVG		
AVG	Average temperature Last temperature	Go to HAL		
HAL	High alarm set point Last temperature	Go to T/C		
T/C	Thermocouple temp Last temperature	Go to LAL		
LAL	Low alarm set point Last temperature	Go to AMB		
AMB	Ambient target temp Last temperature	Go to PRN		
PRN	Data Trans. Interval Last temperature	Go to MEM		
MEM	Memory location Last temperature	Go to E		

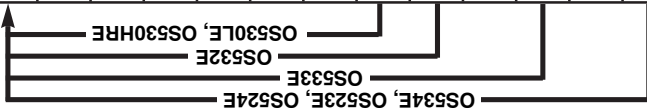

NOTE: The unit of measure (°F or °C) stays on (does not flash) during Recall Mode.

2.4.1 Reviewing the Last Parameters



The thermometer stores the last temperature measured in the real time mode (refer to Table 2-1). This temperature can be recalled by pressing the **FUNC** key.

- Press the **FUNC** key to review the most recently stored temperature data and parameters. You may review:
 - MAX temperature
 - MIN temperature
 - dIF temperature
 - AVG temperature
 - TC temperature
 - HAL temperature
 - LAL temperature
 - AMB temperature
 - MEM location
- } Calculated values
- } Set values

2.4.2 Reviewing Previously Stored Temperature Data (OS534E, OS523E, OS524E)

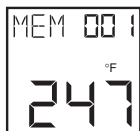

You can review all 800 stored temperature values on the thermometer display using the following procedure:

1. Press and hold the **FUNC** key until you see the Memory Display Mode (MEM) appear.
2. Press the **▲*** key to increment the memory location or press the **◀°F** key to decrement the memory location. The memory location can be from 001 to 800.
3. Press the **LOCK** key. The stored temperature is shown in the lower portion of the display. If there is no data stored in a memory location, the display shows "----".

NOTE

If no keys are pressed, the thermometer goes into sleep mode in approximately 5 seconds.

3.1 Warnings and Cautions

CAUTION

You may receive harmful laser radiation exposure if you do not adhere to the warnings listed below:

- **USE OF CONTROLS OR ADJUSTMENTS OR PERFORMANCE OF PROCEDURES OTHER THAN THOSE SPECIFIED HERE MAY RESULT IN HAZARDOUS RADIATION EXPOSURE.**
 - **DO NOT LOOK AT THE LASER BEAM COMING OUT OF THE LENS OR VIEW DIRECTLY WITH OPTICAL INSTRUMENTS - EYE DAMAGE CAN RESULT.**
 - **USE EXTREME CAUTION WHEN OPERATING THE LASER SIGHTING.**
 - **NEVER POINT THE LASER BEAM AT A PERSON.**
 - **DO NOT ATTEMPT TO OPEN THE THERMOMETER. THERE ARE NO USER SERVICEABLE PARTS INSIDE.**
 - **KEEP OUT OF REACH OF ALL CHILDREN.**
-

Refer to the inside back cover for product warning label.

3.2 Description

The Laser Sighting is built into the thermometer. It provides a visual indication of the field of view of the thermometer. Aiming at distant targets (up to 40 feet) becomes much easier by using the Laser Sighting. It is offered in two different models, laser dot, and laser dot/circle switchable. The Laser can be set to either flashing or continuous.

OS53x-CF and OS523-3 — Thermometer with built-in Laser Dot

All other models — Thermometer with built-in Laser Dot/Circle Switchable

Figures 3-1 and 3-2 show the side and front view of the thermometer with the built-in laser sighting.



Figure 3-1. Right Side View of the Thermometer



Figure 3-2. Left Side View of the Thermometer

3.3 Operating the Laser Sighting

1. Set the laser power switch to the ON position as shown in Figure 3-2.
2. Aim at the target and pull the trigger.
3. The laser beam and the red power indicator LED will turn on. Refer to Figure 3-1 and Figure 3-2.

The laser beam will stay on as long as the trigger is pulled. If the trigger is locked (the **LOCK** key is previously pressed) or released, the laser beam will turn off. In order to turn on the Laser Sighting, pull the trigger again.

4. Depending on the model, the laser dot/circle switch allows the user to switch between laser dot and laser circle. The laser dot provides visibility at longer distances.

Figure 3-3 shows the two different laser configurations. The Laser Dot indicates the center of the field of view of the thermometer. The Laser Circle indicates the perimeter of the thermometer's field of view.

The visibility of the laser beam depends on the ambient light levels.

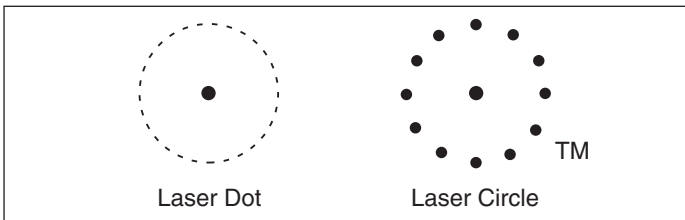

Figure 3-3. Two Laser Configurations

3.4 Laser Sighting Status

In the LSR display menu, the status of the laser sighting is shown either as Flashing (FLS) or continuous (on). Pressing the **LOCK** key will change the status from flashing to continuous and vice versa. There is a slide laser power switch on the left side of the thermometer's case. Set the power switch to ON position, and pull the trigger. The laser beam will stay on (either flashing or continuous depending on the status) as long as the trigger is pulled. Releasing the trigger will automatically turn off the laser beam.

NOTE

The Laser Sighting turns on only when used with the thermometer. The module does not turn on by itself.

The line of sight of the thermometer does not coincide with that of the Laser Sighting, as shown in Figure 3-4. The two lines of sight become less critical when measuring distant targets. For example, at 30 feet from the target and a 3 foot diameter target size, there is a 2.7% offset error with respect to the target size. For close-up targets, first make sure the target fills the laser circle, then point it with the center of the beam approximately 1" below the center of the target. A simple method to make infrared measurements is to scan the laser beam across the target area vertically and horizontally and recall measurements of maximum for hot and minimum for cold target (compared to the background) to obtain the correct temperature.

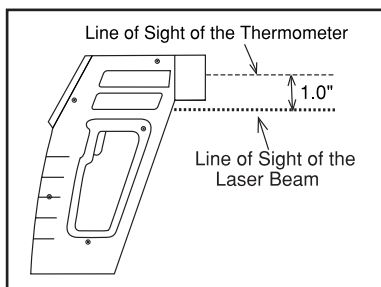

Figure 3-4 Lines of Sight of the Laser Sighting and Thermometer

4.1 Sighting Scope

The Sighting scope is an accessory for the thermometer. It provides a visual indication of the target being measured. Aiming at distant targets (up to 200 feet) becomes much easier by using the Sighting scope.

4.2 Installing and Operating the Sighting Scope

1. If the sighting scope is already installed on the thermometer, go onto step 5.
2. The sighting scope comes with a pair of mounting clamps already attached.
3. Slide the pair of mounting clamps over the "V" groove of the thermometer from back to front as shown in FIG 4-1. DO NOT remove the protective label from the laser sight power contacts.
4. Using the two mounting screws of the clamp, tighten the sighting scope to the pair of clamps and the thermometer.
5. Look through the sighting scope at an arm's length. You will see a crosshair indicating the center of the target being measured.
6. Aim at the target and pull the trigger.

Since the sighting scope mounts on top of the thermometer, the line of sight of the thermometer does not coincide with that of the sighting scope, as shown in Fig. 4-1. The distance between the two lines of sight ($1\frac{1}{6}$ ") becomes less critical compared to the target size when measuring distant targets (50 feet and longer).

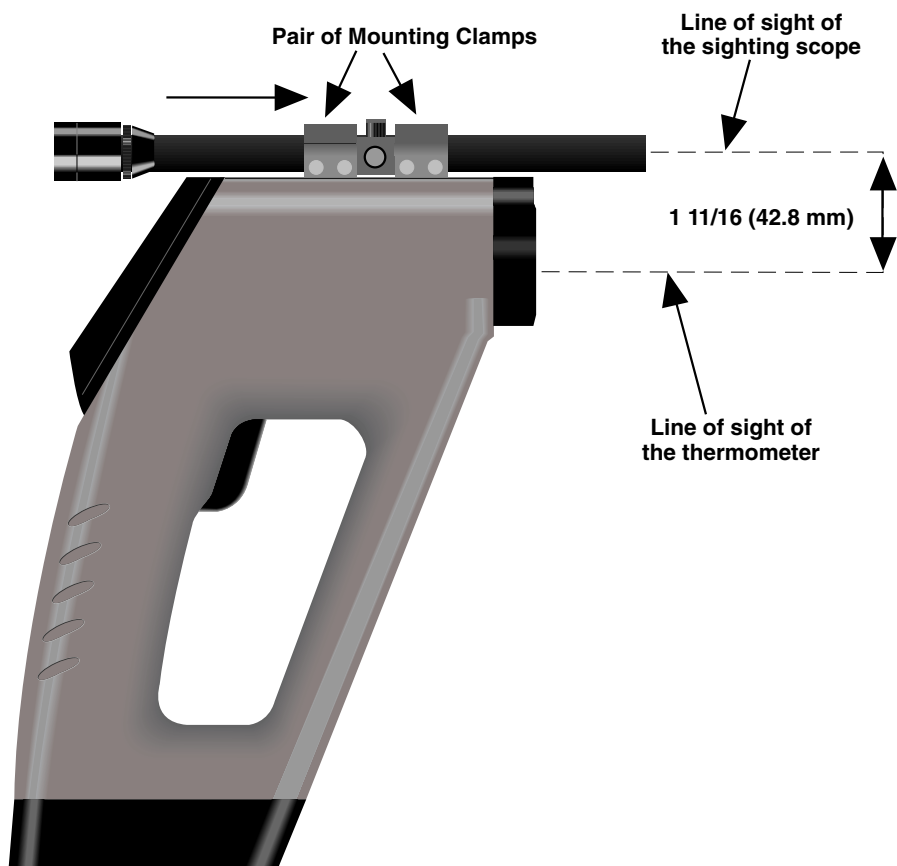
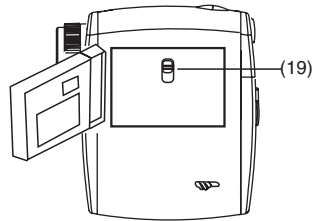
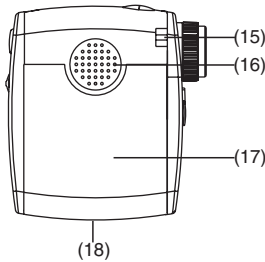
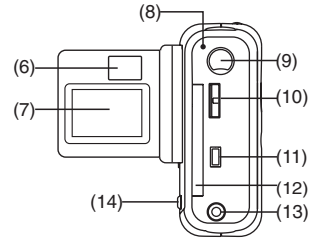
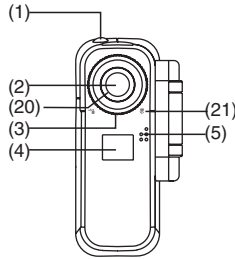

Figure 4-1. Installing the Sighting Scope

5.1 Camera Parts

- (1) Shutter
- (2) Lens
- (3) Focus
- (4) Mirror
- (5) Microphone
- (6) View finder
- (7) LCD display
- (8) LED light
- (9) Record button
- (10) MENU button
- (11) USB port
- (12) CF memory card slot
- (13) AV-out port
- (14) Eject (CF Card)
- (15) Strap-holder
- (16) Speaker
- (17) Battery cover
- (18) Tripod port
- (19) LCD power control
- (20) Far field focus
(101.6 cm [40"] to infinity)
- (21) Close field focus
(40-100 cm [16"-40"])



5.2 Battery Installation

Your camera runs on two AA alkaline batteries. High performance batteries are recommended for this camera for maximum battery life.

5.3 Turning Camera ON/OFF

Press and hold the MENU button for 3 seconds to turn on or off the camera.

5.4 Menu Selection

After turning on the camera, press MENU button to show MENU. To exit MENU, select  on LCD display. See Mode Selecting.

Rotate the wheel  (MENU control) up or down to shift between modes.

Press the wheel  to select mode.

For additional information please refer to the Digital Video Camera's manual available on the accompanying CD.

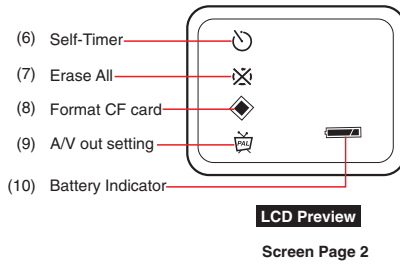
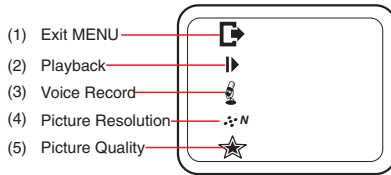

6.1 Replacing the Batteries

NOTE

When you change the batteries, all of the set parameters (i.e. emissivity, high alarm, low alarm, Target Ambient Temperature) will be reset to the default values. For your convenience, you may want to write down all of the set parameters BEFORE replacing the batteries.

The thermometer is powered by 4 standard AA size lithium batteries. To replace the batteries:

1. Invert the thermometer and open the cover of the battery compartment.
2. Remove the old batteries.
3. Install 4 fresh AA size (lithium or alkaline) batteries as shown in Figure 2-1.
4. Close the battery compartment cover.

NOTE

When the battery power is so low that accurate measurements are no longer possible, you must replace the batteries immediately.

You will see and hear the following:

- The **LOBAT** icon flashes
- The thermometer beeps intermittently
- The thermometer flashes " _ _ _ " in the main display.

Safety Warning

Do not open batteries, dispose of in fire, heat above 100°C (212°F), expose contents to water, recharge, put in backwards, mix with used or other battery types – may explode or leak and cause personal injury.

6.2 Cleaning the Lens

Although all lenses are quite durable, take care to prevent scratching when cleaning them. To clean the lens:

1. Blow off loose particles, using clean air.
2. Gently brush off remaining particles, using a camel hair brush. Alternatively, clean any remaining contaminants with a damp, soft, clean cloth. Be careful not to rub too hard.

CAUTION

Do not use any ammonia or cleaners with ammonia on the lens, as damage may result. Do not wipe the surface dry, as this may cause scratching.

6.3 Calibrating the Thermometer



The thermometer can not be calibrated by the user. For precise calibration of the thermometer, call our Customer Service Department. It is recommended that the Infrared Thermometer to be sent to the factory once a year for recalibration.

6.4 Servicing the Laser Sighting

Servicing and maintenance is not required to keep the laser sighting in proper operating condition. In the event of a malfunction, the unit should be returned to the manufacturer for repair.

THERMOMETER

Problem	Solution
<p>The thermometer does not turn on (No Display)</p>	<ol style="list-style-type: none"> 1 a. Properly install fresh batteries. 1 b. If operating under ac power, check that the ac adapter is plugged in properly to the ac wall outlet and to the thermometer. 1 c. Make sure the batteries make good contact - remove and reinstall the batteries. 2. Make sure that the trigger is pulled completely.
<ul style="list-style-type: none"> - The LOBAT icon flashes. - The thermometer beeps intermittently. - The thermometer flashes in the Main Display. 	<ol style="list-style-type: none"> 1. Properly install fresh batteries.

Problem	Solution
The thermometer is "locked up" (the display is "frozen").	Remove and reinstall the batteries or disconnect and reconnect the ac adapter.
The display is either erratic or stays at one reading.	<ol style="list-style-type: none"> 1. Clean the thermometer lens. Refer to Section 4.2. 2. Activate the Diagnostic routine of the thermometer as follows (while looking at room temp): <ol style="list-style-type: none"> a. Pull the trigger and press the  key to lock the trigger. b. Press the  key and  key at the same time. <p>You can expect to see and hear the following:</p> <ul style="list-style-type: none"> • You will see the model and version number "VER X.X" of the software for about 1 second. • You will hear a beep, "TST" is displayed. • Soon after, all of the segments of the display including the backlighting will light up for about 1 second. • The display will clear and a PAS (pass) or ERR (error) code may be seen on the display. <ul style="list-style-type: none"> ERR1: Infrared temp reading is $>150^{\circ}\text{F}$ or $<23^{\circ}\text{F}$. ERR2: Ambient temp $>122^{\circ}\text{F}$ or $<32^{\circ}\text{F}$ ERR3: Can not read from EEPROM memory EER4: Can not write to EEPROM memory



Problem	Solution
<p>The temperature reading is erratic. The thermometer has just been moved from one extreme temperature to room temperature [0°C or 50°C (32°F or 122°F)] or vice versa.</p>	<ol style="list-style-type: none"> <li data-bbox="543 212 937 386">1. The thermometer has to stabilize before taking temperature measurements. It takes up to 30 minutes for the thermometer to stabilize.
<p>The temperature reading is erratic. The thermometer has just been moved from room temperature (ambient temperature) to a temperature 10°C colder or warmer.</p>	<ol style="list-style-type: none"> <li data-bbox="543 514 937 672">1. The thermometer has to stabilize before taking temperature measurements. It takes up to 20 minutes for the thermometer to stabilize.
<p>No Laser Beam</p>	<ol style="list-style-type: none"> <li data-bbox="543 764 926 922">1. Make sure the trigger is pulled and the laser power switch is turned on. (The red power LED should be lit).
<p>The Laser "line of sight" does not coincide with the center of the target.</p>	<ol style="list-style-type: none"> <li data-bbox="543 985 948 1159">1. The line of sight and the center of the target are offset by design. (refer to Figure 3-4 and the explanation above it for how to compensate for this).



(Specifications are for all models except where noted)

THERMOMETER

Measuring Temperature Range:	OS530HRE, OS530LE, OS533E, OS532E: OS534E OS523E OS524E	-30°C to 121°C (-22°F to 250°F) -23°C to 538°C (-10°F to 1000°F) -23°C to 871°C (-10°F to 1600°F) -18°C to 1371°C (0°F to 2500°F) 538°C to 2482°C (1000°F to 4500°F)
------------------------------	---	--

Accuracy (24°C or 75°F Ambient Temperature and at emissivity of 0.95 or greater): ±1% of reading or 3°F whichever is greater (2% Rdg for temp > 2000°F for OS524E)

Field of Vision:	OS532E, OS530LE 10:1 OS533E, OS530HRE 20:1 OS534E 30:1 OS53x-CF 0.15" @ 6" OS523E-1 30:1 OS523E-2 60:1 OS523E-3 68:1 OS524E 110:1
------------------	--

Repeatability:	± (1% rdg + 1 digit)
Resolution:	1°C or 1°F (0.1°C or °F for OS530HRE)
Response Time:	100 msec
Spectral Response:	8 to 14 microns (2 to 2.5 microns, OS524)
Thermocouple Input:	Type K, -18 to 871°C (0 to 1600°F) (OS532E, OS533E, OS534E only)

Input Connection: SMP Connector

Thermocouple Display Accuracy @ 24°C (75°F) Ambient Temperature:	±3°C (±5°F)
--	-------------

Thermocouple Display Response Time:	2 seconds
Operating Ambient Temperature:	0°C to 50°C (32°F to 122°F)

Operating Relative Humidity: 95% or less without condensation

Display:	Backlit LCD dual display
Keypad:	4 position, tactile feed-back membrane switch

Average Temperature Accuracy Time Period (under continuous operation):	30 days
Emissivity:	0.10 to 1.00 in 0.01 increments, set via keypad
Calculated Temperature Values:	Maximum (MAX), Minimum (MIN), Average (AVG), Differential (dIF), Thermocouple (TC)
Ambient Target Temperature Compensation:	Set and enabled via keypad (OS533E, OS534E, OS523E, OS524E)
RS232 Output (for personal computers and serial printers):	Standard on OS533E, OS534E, OS523E, OS524E 9600 bits per second, 8 bits of data, 1 stop bit, no parity
RS-232 Cable:	RJ12 to 9 pin D connector, Female <u>RJ12 Pin #</u> <u>9 pin D connector Pin #</u> 3 TX 2 RX 4 RX 3 TX 5 GND 5 GND
Analog Cable:	6 feet long; 2-conductor, 22 AWG 3.5mm male plug
Alarm:	Set and enabled via keypad All models: High alarm standard, with audible and visual indication OS533E, OS534E Low alarm standard, with OS523E, OS524E: audible and visual indication
Data Storage:	OS534E, OS523E Up to 800 temperature data points. OS524E:
Aiming Feature:	"V" groove on top of the thermometer or use Laser Sighting
Analog Output:	1 mV/°F or 1 mV/°C, set via keypad (0.5 mV/Deg, OS524E)
Analog Output Accuracy:	±2mV reference to temperature display
Power:	4 AA size 1.5 volt batteries (lithium or alkaline)
Battery Type	
Alkaline	General brand
Lithium:	Eveready Energizer, model number L91 BP-2
Battery Storage Temperature	-40°C to 50°C (-40°F to 122°F)

ac adapter: Optional - 100 to 240 Vac. 50-60 Hz, UL, CE, FCC, CE marketing

Output voltage: 9 Vdc at 1.7 A

Output plug (female): Center positive, coax 2.0/5.5/10mm



Low Battery Indicator: LOBAT icon and intermittent beep

Alkaline Battery Life at 24°C
(75°F) ambient temperature

Without Laser Sighting 80 Hours, continuous operation

With Laser Sighting 15 Hours, continuous operation

With LCD backlight & no laser 24 Hours, continuous operation

With Built-in Distance Module 50 Hours, continuous operation

With Built-in Distance Moduler active 4 Hours, continuous operation

Lithium Battery Life at 24°C
(75°F) ambient temperature

Without Laser Sighting 14 Days, continuous operation

With Laser Sighting 2.5 Days, continuous operation

With LCD backlight & no laser 4 Days, continuous operation

With Built-in Distance Module 8 Days, continuous operation

With Built-in Distance Moduler active 15 Hours, continuous operation

Sighting Scope

Magnification: 1.5x

Tripod Mount: ¼"-20 UNC

Wrist Strap: Attached to the thermometer case

Soft Carrying Case: Standard

Dimensions: 218.4 x 167.6 x 50.8 mm
(8.6" x 6.6" x 2.0")

Weight: 0.585 kg (1.3 lbs)

LASER SIGHTING

Wavelength (Color):	630-670 nanometers (red)
Operating Distance:	
Laser Dot	2 to 40 ft.
Laser Circle	2 to 15 ft.
Max. Output Optical Power:	<1 mW at 75°F ambient temperature, Class II Laser Product
European Classification:	Class 2, EN60825-1
Maximum Operating Current:	25mA at 5.5 V
FDA Classification:	Complies with 21 CFR Chapter 1, Subchapter J
Beam Diameter:	5 mm
Beam Divergence:	<2mrad
Laser Configuration:	Dot/Circle switchable except for OS53x-CF and OS523E-3 models
Laser Status:	Flashing or continuous, set via keypad
Operating Temperature:	0°C to 50°C (32°F to 122°F)
Operating Relative Humidity:	95% or less without condensation
Power Switch:	Slide switch, ON - OFF
Power Indicator:	Red LED
Power:	Supplied by the thermometer
Identification Label:	Located on the bottom of the thermometer
Warning & Certification Label:	Located on the left side of the thermometer (for the label layout, refer to the inside back cover)

DISTANCE MEASURING (Model HH-DM)











Range:	0.9 to 9 m (3' to 30')
Accuracy:	1% of Rdg or 3 cm (0.1') whichever is greater
Units of Measure:	Meter or Feet – switchable via C button
Sensor:	Ultrasonic transducer
Power:	9 Volts Battery
Battery Life:	50 hours, continuous
Operating ambient temperature:	0 to 40°C
Operating relative humidity:	30 to 70% RH
Auto power shut off:	Approx. 7 minutes after the last key press

DISTANCE MEASURING (Built-in-DM)

Size	133 x 73 x 33mm (5.25" x 2.87" x 1.3")
Weight	170 g Range: 0.9 to 9 m (3' to 30')
Accuracy:	1% of Rdg or 3 cm (0.1') whichever is greater
Units of Measure:	Meter or Feet – switchable via keypad
Sensor:	Ultrasonic transducer
Power:	From infrared thermometer
Battery Life:	4 hours, continuous (Alkaline Battery) 15 hours, continuous (Lithium Battery)
Operating ambient temperature:	0 to 50°C
Operating relative humidity:	Less than 80% RH

DIGITAL VIDEO CAMERA

Display:	1.4" Color LCD
Digit Still Camera:	
2M:	1600 x 1200 pixels
SXGA:	1280 x 1024 pixels
VGA:	640 x 480 pixels
PC Camera:	
VGA:	(640 x 480 pixels)/10 fps
QVGA:	(320 x 240 pixels)/24 fps
Digital voice recording:	About 4 min/1 MB memory
PC interface:	USB port
A/V output:	Supports NTSC/PAL TV systems
Internal Memory:	16 MB SDRAM
Memory Card, CF:	32 MB, included
Self Timer:	10 seconds
Power:	Two AA size batteries
Size:	68 x 41 x 84 mm (2.7" x 1.6" x 3.3")

Key(s)	Key(s) Functions
	<ul style="list-style-type: none"> Selects one of the following Display Modes: E, d-F, d-M, MAX, MIN, dIF, AVG, TC, HAL, LAL, AMB, PRN, MEM or LOG.
	<ul style="list-style-type: none"> Locks/unlocks the trigger. Enables/disables High & Low Alarm. Enables/disables Target Ambient Temperature Compensation. Enables/disables sending data to the personal computer or serial printer. Stores temperature data on command. Displays previously stored data. Resets Min, Max, AVG values
	<ul style="list-style-type: none"> Increments the data or value displayed. Turns on or off the backlighting (only in MAX, MIN, dIF, TC or AVG Display Modes).
	<ul style="list-style-type: none"> Decrements the data or value displayed. Changes the unit of measure from °F to °C or vice versa (only in MAX, MIN, dIF, TC or AVG Display Modes).
<p>Press the  key & the  key together</p>	<ul style="list-style-type: none"> Allows you to go to the Diagnostic Routine.
<p>Press the  & the  keys together</p>	<ul style="list-style-type: none"> Allows you to erase all 800 stored temperature data from the memory.
<p>Press and Hold  Key Pull the trigger Release trigger Release  Key</p>	<ul style="list-style-type: none"> Reset the thermometer. It sets all parameters to default values.

Notes

Thermal Radiation

Heat is transferred from all objects via radiation in the form of electromagnetic waves or by conduction or convection. All objects having a temperature greater than absolute zero (-273°C, -459°F, 0 K) radiate energy. The thermal energy radiated by an object increases as the object gets hotter. Measurement of this thermal energy allows an infrared thermometer to calculate the object's temperature if the emissivity (blackness) is known. Generally, it is convenient to measure the amount of radiated energy in the infrared part of an object's radiation spectrum.

Figure A-1 shows a block diagram of an infrared radiation thermometer. Energy from the object is focused by the lens onto the detector. As the detector heats up, it sends out an electrical signal, which in turn is amplified and sent to the circuitry of the thermometer. The thermometer software then calculates the temperature of the object.

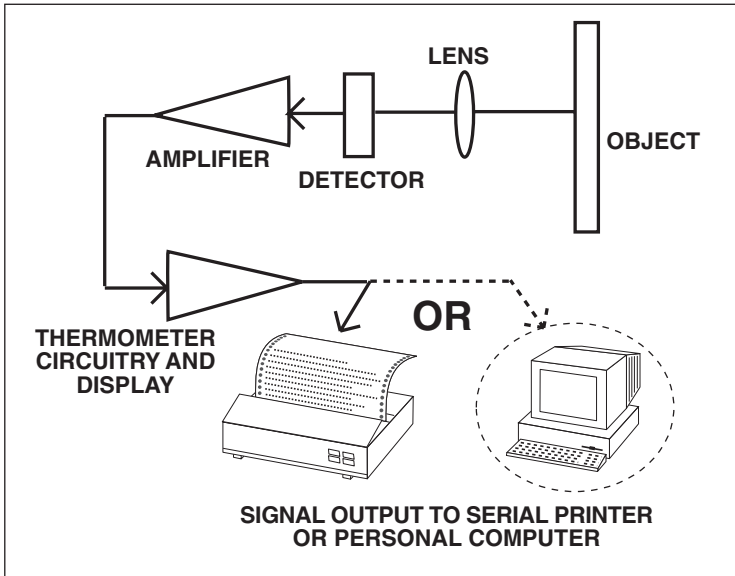

Figure A-1. Infrared Thermometer Block Diagram

Blackbody

When thermal radiation falls on an object, part of the energy is transmitted through the object, part is reflected and part is absorbed. A blackbody is defined as an ideal object that absorbs all the radiation incident upon it. The best example of a real object that acts like a blackbody is a small hole drilled deep into a large opaque cavity. Thermal radiation entering the cavity is internally reflected and has little chance of escaping the cavity before it is fully absorbed.

Emissivity is defined as the ratio of energy radiated by an object to that of the energy radiated by a blackbody. By definition, the emissivity of a blackbody is 1. Most objects are considered *gray objects* with an emissivity between 0 and 1. Various emissivities for common materials are shown in Appendix B.

Spectral Distribution

Objects radiate energy at different wavelengths, but not with constant intensity at each wavelength. Figure A-2 shows the energy radiated by a blackbody at various temperatures as a function of wavelength. As a body is heated, the intensity of the radiated energy increases and the peak of the curve shifts towards the shorter wavelength end of the spectrum. The total area under a spectral distribution curve is proportional to the total energy radiated by the blackbody at a given temperature.

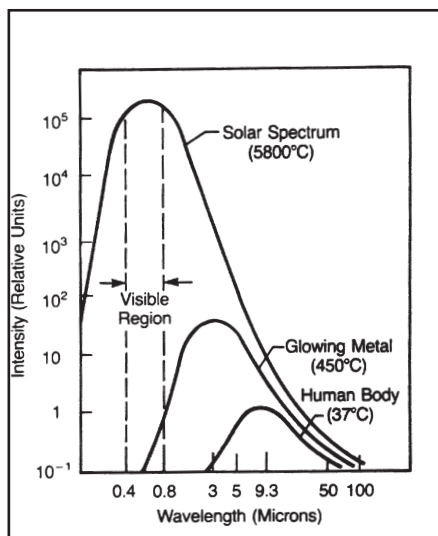

Relative emission from a blackbody versus wavelength. The area under the curve corresponds to the total energy, and is proportional to the absolute temperature to the 4th power. The peak of the spectral distribution curve shifts to shorter wavelengths as the temperature increases.

Figure A-2. Blackbody Spectral Distribution

Wien's Displacement Law describes the exact mathematical relationship between the temperature of a blackbody and the wavelength of the maximum intensity radiation.

$$\lambda_m = \frac{2.898}{T}$$

where λ_m = wavelength measured in microns
T = temperature in Kelvin

Calculating Temperature

The net thermal power radiated by an object has been shown to depend on its emissivity, its temperature and that of the ambient temperature around the object. A very useful equation known today as the Stefan-Boltzmann Law has been shown both theoretically and empirically to describe the relationship.

$$I = \epsilon\sigma(T^4 - T_a^4)$$

I = thermal power in watts/meter²

ϵ = Emissivity

σ = 5.6703×10^{-8} watts/meter² x K⁴ (Stefan's constant)

T = temperature of object in Kelvin

T_a = temperature of ambient surroundings in Kelvin

The infrared thermometer uses this equation directly in calculating the temperature of an object. The incident power is measured by the infrared detector. The emissivity of the object is determined by the user. The ambient temperature is measured by a sensor inside the thermometer. With all quantities known, the thermometer uses the Stefan-Boltzmann Law to calculate and output the temperature of the object.

Optics Field of View

Accurate measurement of temperature via infrared means depends strongly on the size of the object and the distance between the thermometer and the object. All optical devices (e.g. cameras, microscopes, infrared thermometers) have an angle of vision, known as a field of view or FOV, within which they see all objects. In particular, the thermometer will measure a fixed proportion of the energy radiated by all objects within its FOV. The user must guarantee that the distance between the thermometer and the object is defined so that only that object fills the FOV of the instrument.

Referring to Figure A-3, Objects "X" and "Y" are within the FOV of the thermometer. The measured temperature would fall somewhere between the actual temperatures of the two objects. In order to measure the temperature of Object "X" accurately, Object "Y" would need to be removed. In order to measure the temperature of Object "Y" accurately, the user would need to move closer to Object "Y" until it completely filled the FOV of the thermometer. Alternatively, the user could measure the temperature of Object "Y" with a thermometer with a smaller FOV.

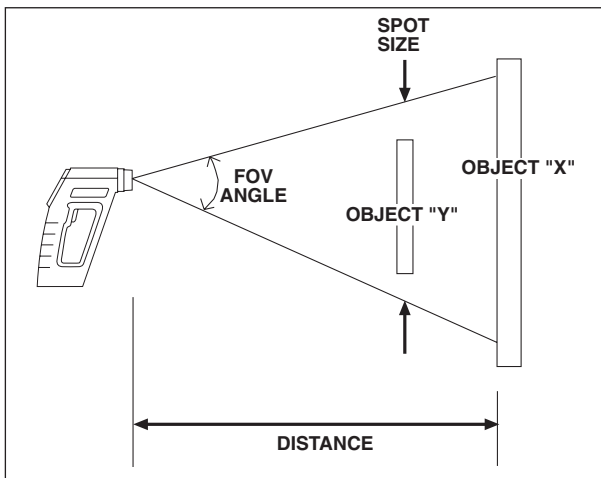

Figure A-3. Field of View of a Thermometer

The distance-to-spot size ratio ($\%$) defines the field of view (FOV). Thus, a $\%$ = 10 gives you approximately a 1 foot spot size at a distance of 10 feet. For accurate spot size values, refer to the Field of View diagrams shown in Figures 2-4 through 2-6.

Table B-1 provides *guidelines for estimating the emissivity* of various common materials. Actual emissivity, especially of metals, can vary greatly depending upon surface finish, oxidation, or the presence of contaminants. Also, emissivity or infrared radiation for some materials varies with wavelength and temperature. To determine the *exact emissivities* for most applications, follow the procedures in Appendix C.

Table B-1. Emissivity Table

Material	Emissivity (ϵ)
<u>Aluminum</u> – pure highly polished plate	0.04 to 0.06
<u>Aluminum</u> – heavily oxidized	0.20 to 0.31
<u>Aluminum</u> – commercial sheet	0.09
<u>Brass</u> – dull plate	0.22
<u>Brass</u> – highly polished, 73.2% Cu, 26.7% Zn	0.03
<u>Chromium</u> – polished	0.08 to 0.36
<u>Copper</u> – polished	0.05
<u>Copper</u> – heated at 600°C (1110°F)	0.57
<u>Gold</u> – pure, highly polished or liquid	0.02 to 0.04
<u>Iron and steel (excluding stainless)</u> – polished iron	0.14 to 0.38
<u>Iron and steel (excluding stainless)</u> – polished cast iron	0.21
<u>Iron and steel (excluding stainless)</u> – polished wrought iron	0.28
<u>Iron and steel (excluding stainless)</u> – oxidized dull wrought iron	0.94
<u>Iron and steel (excluding stainless)</u> – rusted iron plate	0.69
<u>Iron and steel (excluding stainless)</u> – polished steel	0.07
<u>Iron and steel (excluding stainless)</u> – polished steel oxidized at 600°C (1110°F)	0.79
<u>Iron and steel (excluding stainless)</u> – rolled sheet steel	0.66
<u>Iron and steel (excluding stainless)</u> – rough steel plate	0.94 to 0.97
<u>Lead</u> – gray and oxidized	0.28
<u>Mercury</u>	0.09 to 0.12
<u>Molybdenum filament</u>	0.10 to 0.20
<u>Nickel</u> – polished	0.07
<u>Nickel</u> – oxidized at 649 to 1254°C (1200°F to 2290°F)	0.59 to 0.86
<u>Platinum</u> – pure polished plate	0.05 to 0.10
<u>Platinum</u> – wire	0.07 to 0.18
<u>Silver</u> – pure and polished	0.02 to 0.03
<u>Stainless steel</u> – polished	0.07
<u>Stainless steel</u> – Type 301 at 232 to 941°C (450°F to 1725°F)	0.54 to 0.63
<u>Tin</u> – bright	0.06
<u>Tungsten</u> – filament	0.39
<u>Zinc</u> – polished commercial pure	0.05
<u>Zinc</u> – galvanized sheet	0.23

METALS

Material	Emissivity (ϵ)
<u>Asbestos Board</u>	0.96
<u>Asphalt, tar, pitch</u>	0.95 to 1.00
<u>Brick</u> – red and rough	0.93
<u>Brick</u> – fireclay	0.75
<u>Carbon</u> – filament	0.53
<u>Carbon</u> – lampblack - rough deposit	0.78 to 0.84
<u>Glass</u> - Pyrex, lead, soda	0.85 to 0.95
<u>Marble</u> – polished light gray	0.93
<u>Paints, lacquers, and varnishes</u> – Black matte shellac	0.91
<u>Paints, lacquers, and varnishes</u> – aluminum paints	0.27 to 0.67
<u>Paints, lacquers, and varnishes</u> – flat black lacquer	0.96 to 0.98
<u>Paints, lacquers, and varnishes</u> – white enamel varnish	0.91
<u>Porcelain</u> – glazed	0.92
<u>Quartz</u> – opaque	0.68 to 0.92
<u>Roofing Paper</u>	0.91
<u>Tape</u> – Masking	0.95
<u>Water</u>	0.95 to 0.96
<u>Wood</u> – planed oak	0.90

In Appendix A, we showed how emissivity is an important parameter in calculating the temperature of an object via infrared means. In this section we discuss how to determine a specific emissivity value. If you know the material of the object, use Table B-1 in Appendix B to look up its approximate emissivity. Most organic materials such as plastics, cloth, or wood have an emissivity of about 0.95. For this reason, we use 0.95 as the default emissivity setting in the OS530 Series Thermometer.

For objects of unknown material or for very precise measurements, use one of the following methods to determine a specific emissivity value.

Method 1

1. Measure and record the temperature of the object using a contact temperature probe such as a thermocouple or RTD.
2. Aim the thermometer at the object.
3. Adjust the emissivity until the temperature reading of the thermometer equals the temperature measured in Step 1.

Method 2

1. Heat the object (or at least a sample of the object material) on top of a heating plate to a known temperature. Make sure the thermometer and the air surrounding the heating plate are at the same temperature.
2. Measure the temperature of the object material with the thermometer. Make sure that the object fills the FOV of the thermometer.
3. Adjust the emissivity until the temperature reading of the thermometer equals the known temperature of Step 1.

Method 3

1. Use this method to measure objects at temperatures below 260°C (500°F).
2. Place a large piece of masking tape on the object (or at least a sample of the object material). Allow time for the masking tape to reach the object temperature.
3. Set the emissivity of the thermometer to 0.95. Use the thermometer to measure and record the temperature of the masking tape - Area 'A' in Figure C-1. Make sure that the area of the object covered with masking tape fills the FOV of the thermometer.

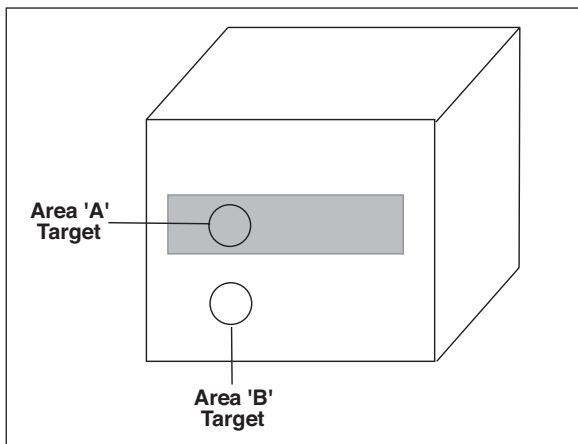

Figure C-1. Determining Emissivity

4. Aim the thermometer at Area 'B' as shown in Figure C-1. Make sure that Area 'B' is as close as possible to Area 'A'.
5. Adjust the emissivity of the thermometer until the temperature reading equals the temperature found in Step 3.

Method 4

1. Paint a sample of the object material with flat black lacquer paint.
2. Set the emissivity to 0.97 and measure and record the temperature of the painted portion of the sample material - Area 'A' in Figure C-1. Make sure that the painted area of object material fills the FOV of the thermometer.
3. Aim the thermometer at another spot on the target - Area 'B' in Figure C-1.
4. Adjust the emissivity of the thermometer until the temperature reading equals the temperature found in Step 2.

Method 5

1. Use this method where practical to measure objects at temperatures above 260°C (500°F).
2. Drill a 35 mm (1.5") diameter hole in a sample of the object material to a depth of 127 mm (5"). This hole closely resembles a blackbody (refer to Appendix A).

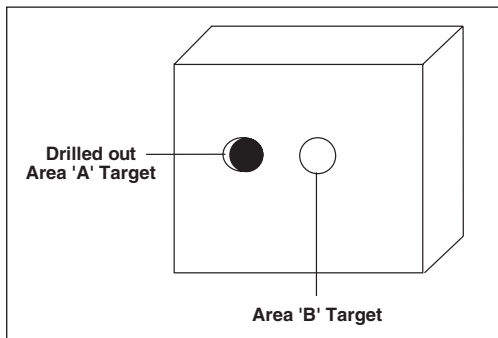

Figure C-2. Determining Emissivity with a Drilled Hole

3. Set the emissivity to 0.97 and measure and record the temperature of the hole in the sample material - Area 'A' in Figure C-2. Make sure that the hole fills the FOV of the thermometer.
4. Aim the thermometer at another spot on the target as close as possible to Area 'A' (Area 'B' in Figure C-2).
5. Adjust the emissivity of the thermometer until the temperature reading equals the temperature found in Step 3.

A

- ac Adapter Input Jack 1-7
- Active Operation 2-9
- Aiming Sight "V Groove" 1-2, 1-5
- Alarms 2-16, 2-17
- Alkaline Batteries 2-1, 5-1, 6-1
- Ambient Target Temperature
 Compensation 2-18, 2-19, 2-28
- Analog Output Jack 1-7

B

- Backlighting Icon 1-5
- Battery(s):
 - Compartment 1-5, 2-1, 6-1
 - Installing AA size..... 2-1, 5-1
 - Life of 8-3
- Blackbody A-2, A-3, C-3
- Beeping Sound 2-16, 2-26, 6-1,
 7-1, 7-2

C

- Carrying Case 1-2
- Chart Recorder Hookup 2-8
- Computer:
 - Parameters:
 - Speed, Data, Parity,
 Stop Bit 2-21, 2-24, 2-26, 2-28,
- 2-31
- Personal, Hookup 2-20
- Program (IRTM)
 - 2-20, 2-21, 2-22

D

- Diagnostic Program 7-2, 9-1
- Differential Measurement 2-7
- Display
 - Icons:
 - ATC 1-6
 - Backlighting 1-6
 - HAL 1-6
 - LAL 1-6
 - LCK 1-6
 - LOBAT 1-6
 - PRN 1-6
 - Modes:
 - AMB 1-6
 - AVG 1-6
 - dIF 1-6
 - E 1-6
 - HAL 1-6
 - LAL 1-6
 - MAX 1-6
 - MEM 1-6
 - MIN 1-6
 - PRN 1-6
 - Problems 7-1, 7-2, 7-3
- Distance
 - Built-in 2-14, 2-15
 - Meter (HH-DM) 2-14, 2-15
 - Field of Views 2-14, 2-15
- Digital Video Camera..... 5-1

E

- Emissivities:
 - Adjusting 2-12
 - Definition A-2
 - Figuring out Unknown C-1
 - Values B-1
- Erasing Temperature Data ... 2-28
- Error Codes 7-1, 7-2, 7-3



F

- Field of View:
 - Diagrams 2-2 to 2-6
 - Positions 2-2
- Fixed Point Monitoring over Time Measurement 2-8

G

- Gray Bodies (Objects) A-2

H

- High Alarm Value, setting 2-16, 2-27

I

- Icons:
 - ATC 1-6
 - Backlighting 1-6
 - HAL 1-6
 - LAL 1-6
 - LCK 1-6
 - LOBAT 1-6
 - PRN 1-6
- Installing
 - AA Batteries 2-1
 - Laser Sight Module 3-3, 3-4

J

- Jacks
 - ac Adapter Input 1-7
 - Analog Output 1-7
 - RS-232 Phone 1-7

K

- Keypad, 4-position 1-6
- Keys:
 - ▼ & °F-°C 1-6
 - FUNC (Function) 1-6
 - LOCK (Lock) 1-6
 - ▲ & ○-● 1-6
- Key Strokes 9-1

L

- Label Layout:
 - Danger & Certification Inside Back Cover
- Laser Sight Module:
 - Laser Circle 3-3
 - Laser Dot 3-3
 - Installing onto
 - Thermometer 3-4
 - Line of Sight 3-4
 - Power Button 2-2, 3-2
 - Problems 7-1 to 7-3
 - Power Indicator LED.... 2-2, 3-3
 - Removing from
 - Thermometer 3-4, 3-5
 - Status 2-15
 - Warnings and Cautions 3-1
- LCD, Backlit 1-5 to 1-7
- Lens Cleaning 6-2
- Lines of Sight of the Module and Thermometer 3-4
- Lithium Batteries 2-1, 6-1, 8-3
- Lock Function 2-12
- Low Alarm Value, setting 2-17



M

- Main Display 1-4
- Modes:
 - Real Time 2-8
 - Recall 2-23, 2-25
- Moving Surface Scan 2-7

O

- Optics A-4

P

- Parameters, reviewing 2-27
- PAS Code 5-2
- Passive Operation 2-25
- Personal Computer
 - Hookup 2-19
- Power Contacts:
 - Cleaning 4-2
 - On Laser Sight Module .. 1-4, 4-2
- Power Indicator LED 2-2, 3-2
- Printer, Serial, Hookup 2-17

R

- Real Time Mode Block
 - Diagram 2-8
- Recall Mode Block Diagram ... 2-26
- Replacing AA Batteries 4-1
- RS-232 Phone Jack 1-6
- Rubber Boot:
 - Display 1-4
 - IR Lens 1-4

S

- Serial Printer Hookup 2-8, 2-20
- Sleep Mode 2-6, 2-9, 2-15, 2-29
- Spectral Distribution A-2
- Spot Measurement 2-7
- Sighting Scope 4-1
- Static Surface Scan 2-7
- Stefan-Boltzmann Law A-3
- Storing Temperature Data
 - 2-20, 2-26, 2-27

T

- Temperature Data:
 - Erasing 2-28
 - Storing 2-26, 2-27
- Thermal Radiation A-1
- Thermometer:
 - Front View 1-5
 - Various View 1-7
- Tripod Thread Mount 1-5

V

- “V” Groove Aiming Sight 1-5, 4-1

W

- Wein’s Displacement Law A-3
- Wrist Strap 1-5



WARRANTY/DISCLAIMER

OMEGA ENGINEERING, INC. warrants this unit to be free of defects in materials and workmanship for a period of **25 months** from date of purchase on the base unit and **13 months** from date of purchase on Laser Sight Module. OMEGA Warranty adds an additional one (1) month grace period to the normal **product warranty** to cover handling and shipping time. This ensures that OMEGA's customers receive maximum coverage on each product.

If the unit should malfunction, it must be returned to the factory for evaluation. OMEGA's Customer Service Department will issue an Authorized Return (AR) number immediately upon phone or written request. Upon examination by OMEGA, if the unit is found to be defective it will be repaired or replaced at no charge. OMEGA's WARRANTY does not apply to defects resulting from any action of the purchaser, including but not limited to mishandling, improper interfacing, operation outside of design limits, improper repair, or unauthorized modification. This WARRANTY is VOID if the unit shows evidence of having been tampered with or shows evidence of being damaged as a result of excessive corrosion; or current, heat, moisture or vibration; improper specification; misapplication; misuse or other operating conditions outside of OMEGA's control. Components for which wear is not warranted, includes, but is not limited to, contact points, fuses, and triacs.

OMEGA is pleased to offer suggestions on the use of its various products. However, OMEGA neither assumes responsibility for any omissions or errors nor assumes liability for any damages that result from the use of its products in accordance with information provided by OMEGA, either verbal or written. OMEGA warrants only that the parts manufactured by the company will be as specified and free of defects. OMEGA MAKES NO OTHER WARRANTIES OR REPRESENTATIONS OF ANY KIND WHATSOEVER, EXPRESSED OR IMPLIED, EXCEPT THAT OF TITLE, AND ALL IMPLIED WARRANTIES INCLUDING ANY WARRANTY OF MERCHANTABILITY AND FITNESS FOR A PARTICULAR PURPOSE ARE HEREBY DISCLAIMED. LIMITATION OF LIABILITY: The remedies of purchaser set forth herein are exclusive and the total liability of OMEGA with respect to this order, whether based on contract, warranty, negligence, indemnification, strict liability or otherwise, shall not exceed the purchase price of the component upon which liability is based. In no event shall OMEGA be liable for consequential, incidental or special damages.

CONDITIONS: Equipment sold by OMEGA is not intended to be used, nor shall it be used: (1) as a "Basic Component" under 10 CFR 21 (NRC), used in or with any nuclear installation or activity; or (2) in medical applications or used on humans. Should any Product(s) be used in or with any nuclear installation or activity, medical application, used on humans, or misused in any way, OMEGA assumes no responsibility as set forth in our basic WARRANTY/DISCLAIMER language, and additionally, purchaser will indemnify OMEGA and hold OMEGA harmless from any liability or damage whatsoever arising out of the use of the Product(s) in such a manner.

RETURN REQUESTS / INQUIRIES

Direct all warranty and repair requests/inquiries to the OMEGA Customer Service Department. BEFORE RETURNING ANY PRODUCT(S) TO OMEGA, PURCHASER MUST OBTAIN AN AUTHORIZED RETURN (AR) NUMBER FROM OMEGA'S CUSTOMER SERVICE DEPARTMENT (IN ORDER TO AVOID PROCESSING DELAYS). The assigned AR number should then be marked on the outside of the return package and on any correspondence.

The purchaser is responsible for shipping charges, freight, insurance and proper packaging to prevent breakage in transit.

FOR **WARRANTY** RETURNS, please have the following information available BEFORE contacting OMEGA:

1. P.O. number under which the product was PURCHASED,
2. Model and serial number of the product under warranty, and
3. Repair instructions and/or specific problems relative to the product.

FOR **NON-WARRANTY** REPAIRS, consult OMEGA for current repair charges. Have the following information available BEFORE contacting OMEGA:

1. P.O. number to cover the COST of the repair,
2. Model and serial number of product, and
3. Repair instructions and/or specific problems relative to the product.

PATENT NOTICE: U.S. PAT. D357,194; B1 5,368,392; 5,524,984; 5,727,880; 5,465,838; 5,823,678; 5,823,679; 6,123,453; 6,267,500 B1; 6,341,891 B1; 6,377,400 B1; 6,540,398 B2; 6,614,830 B1; 6,633,434 B2; 6,659,639; / Canada 2,114,806; 2,116,055; 75811 © OMEGA ENGINEERING, INC./ Czech Republic 25372/ France 2 756 920; 2 767 921; 2,773,213; 0378411 to 0378446; 2 773 213 B1 / Germany M 94 06 478.4; G 94 2 197.9; G 94 2 203.7/ Italy RM940000913/ Japan 988,378/Holland 1007752; 25009-00/ Spain mod. ut. 0133292/ Slovak Republic 24565/ U.K. Registered 2041153; 9726133.3/ EPO 0 644, 008 B2; EP 1 085 307 A1. Other U.S. and Foreign Patents Pending.

OMEGA's policy is to make running changes, not model changes, whenever an improvement is possible. This affords our customers the latest in technology and engineering.

OMEGA is a registered trademark of OMEGA ENGINEERING, INC.

© Copyright 2007 OMEGA ENGINEERING, INC. All rights reserved. This document may not be copied, photocopied, reproduced, translated, or reduced to any electronic medium or machine-readable form, in whole or in part, without prior written consent of OMEGA ENGINEERING, INC.

Warning and Certification Label

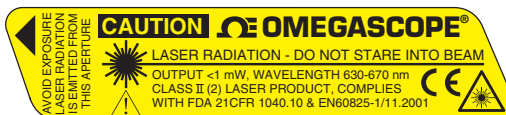

Label Location - refer to Section 3.2

Warnings and Cautions - refer to Section 3.1

Where Do I Find Everything I Need for Process Measurement and Control? **OMEGA...Of Course!** *Shop online at omega.com*

TEMPERATURE

- ☑ Thermocouple, RTD & Thermistor Probes, Connectors, Panels & Assemblies
- ☑ Wire: Thermocouple, RTD & Thermistor
- ☑ Calibrators & Ice Point References
- ☑ Recorders, Controllers & Process Monitors
- ☑ Infrared Pyrometers

PRESSURE, STRAIN AND FORCE

- ☑ Transducers & Strain Gages
- ☑ Load Cells & Pressure Gages
- ☑ Displacement Transducers
- ☑ Instrumentation & Accessories

FLOW/LEVEL

- ☑ Rotameters, Gas Mass Flowmeters & Flow Computers
- ☑ Air Velocity Indicators
- ☑ Turbine/Paddlewheel Systems
- ☑ Totalizers & Batch Controllers

pH/CONDUCTIVITY

- ☑ pH Electrodes, Testers & Accessories
- ☑ Benchtop/Laboratory Meters
- ☑ Controllers, Calibrators, Simulators & Pumps
- ☑ Industrial pH & Conductivity Equipment

DATA ACQUISITION

- ☑ Data Acquisition & Engineering Software
- ☑ Communications-Based Acquisition Systems
- ☑ Plug-in Cards for Apple, IBM & Compatibles
- ☑ Datalogging Systems
- ☑ Recorders, Printers & Plotters

HEATERS

- ☑ Heating Cable
- ☑ Cartridge & Strip Heaters
- ☑ Immersion & Band Heaters
- ☑ Flexible Heaters
- ☑ Laboratory Heaters

ENVIRONMENTAL MONITORING AND CONTROL

- ☑ Metering & Control Instrumentation
- ☑ Refractometers
- ☑ Pumps & Tubing
- ☑ Air, Soil & Water Monitors
- ☑ Industrial Water & Wastewater Treatment
- ☑ pH, Conductivity & Dissolved Oxygen Instruments